

2009

BURNETT & HILLMAN
HYDRAULIC ADAPTORS



www.burnettandhillman.co.uk

PRODUCT CATALOGUE



Burnett & Hillman, Havyat Road, Wrington, Bristol BS40 5AE, United Kingdom

Tel (Sales): +44 (0)1934 862596 Tel (Accounts): +44 (0)1934 862980

Fax: +44 (0)1934 862616 email: sales@burnettandhillman.co.uk

Whatever you need - when you need it.

Since 1965 Burnett & Hillman has dedicated itself to service and quality in the manufacture and distribution of hydraulic adaptors to many industries around the world.

As a specialist manufacturer and supplier Burnett & Hillman believes in customer service. We stock and manufacture the best quality products, and our staff are trained to provide the best back-up to our customers.

We believe that we offer an unbeatable combination of first class service, rapid response, good stocks plus access to a diverse and ever growing product line.

Whatever your requirement, from one-off special to high volume pieces, Burnett & Hillman can provide your company with all your hydraulic adaptor needs.

Our extensive range of adaptors includes stock in excess of 3000 different variations of JIC, SAE, Metric, BSP, BSPT, NPTF, NPSM and ORFS made from mild steel (BS EN 10277:31999 - 230M07 Pb).

Features on the website include:

- Online Catalogue (for customers & guests)
- Technical Help



www.burnettandhillman.co.uk

Description	Section	Page
Male x Male Adaptors	1	4
Male x Swivel Female Adaptors	2	32
Swivel Female x Swivel Female Adaptors	3	43
Male x Fixed Female & Fixed Female/Female Adaptors	4	47
Tees & Cross Adaptors	5	63
Elbow Adaptors	6	77
Plugs, Caps & Crimp Nuts	7	89
Swepts, Push-Ins, hose-tails, & ferrules	8	99
O' Ring Face seal Adaptors	9	108
Forged Adaptors	10	117
JIS Adaptors	11	125
O' Rings, Bonded Seals & Protection Caps	12	130
Conditions of Order		I
Letter of Conformity		II
Pressure Rating Tables		III
Nut Tightening Torques		IV
Map To Burnett & Hillman		V

Contents Section 1

5	BSP male x BSP male
5	BSP male x BSP male flat faced full thread both ends
6	BSP male x BSP male To DIN 3852 FORM A
6	BSP male x BSP male 174 SPEC
7	BSP male x BSP male BS5200 spec
7	BSP male 3869 seal x BSP male
7	BSP male x BSP male bulkhead LESS LOCKNUT
8	BSP Locknut
8	BSP male x BSP male bulkhead WITH LOCKNUT
8	BSP male x BSP male extended bulkhead WITH LOCKNUT
9	BSP male x BSP male extended bulkhead LESS LOCKNUT
9	BSP male x BSPT male
10	BSP male DIN 3852 Form A x BSPT male
11	BSP male x JIC male
12	BSP male DIN 3852 Form A x JIC male
13	BSP male 3869 seal x JIC male
13	BSP male x SAE male 45° external flare
<hr/>	
13	BSPT male x BSPT male
14	BSPT male x NPTF male
14	BSPT male x JIC male
15	BSPT male x SAE male 45° external flare
<hr/>	
15	NPTF male x NPTF male
16	NPTF male x BSP male
17	NPTF male x JIC male
18	NPTF male x JIC male extended
18	NPTF male x SAE male 45° external flare
<hr/>	
19	METRIC male x METRIC male 1.5mm pitch
20	METRIC male x METRIC male bulkhead LESS LOCKNUT 1.5mm pitch
20	METRIC male x METRIC male bulkhead WITH LOCKNUT 1.5mm pitch
20	METRIC Locknut 1.5mm pitch
21	METRIC male 1.5mm pitch x BSP male
21	METRIC male 1.0mm pitch x BSP male
22	METRIC male 1.5mm pitch x BSP male to DIN 3852 Form A
22	METRIC male 1.5mm pitch x JIC male
23	METRIC male 1.5mm pitch 24° cone tube fitting x JIC male
23	METRIC male 2mm pitch 24° cone tube fitting x JIC male
<hr/>	
24	JIC male x JIC male
24	JIC male x JIC male bulkhead LESS LOCKNUT
25	JIC Locknut
25	JIC male x JIC male bulkhead WITH LOCKNUT
<hr/>	
26	SAE male x SAE male 45° external flare
26	SAE male x SAE male 45° external flare LESS LOCKNUT
26	SAE male x SAE male 45° external flare WITH LOCKNUT
26	SAE Locknut
27	SAE O'ring boss male LESS O'RING x BSP male
27	SAE O'ring boss male LESS O'RING x JIC male
28	SAE O'ring boss male WITH O'RING x BSP male
29	SAE O'ring boss male WITH O'RING x JIC male
<hr/>	
30	BSP male x BSP male with restrictor
31	BSP male x BSP male restrictor blank only
31	BSP male x JIC male restrictor blank only
31	METRIC male 1.5mm pitch x JIC male restrictor blank only
31	JIC male x JIC male with restrictor blank only

BSP male x BSP male

Code	Description
00001	1/8 bsp x 1/8 bsp
00002	1/8 bsp x 1/4 bsp
00003	1/8 bsp x 3/8 bsp
00004	1/8 bsp x 1/2 bsp
00005	1/4 bsp x 1/4 bsp
00006	1/4 bsp x 3/8 bsp
00007	1/4 bsp x 1/2 bsp
00008	1/4 bsp x 5/8 bsp
00009	1/4 bsp x 3/4 bsp
00010	1/4 bsp x 1 bsp
00011	1/4 bsp x 1-1/4 bsp
00012	1/4 bsp x 1-1/2 bsp
00013	1/4 bsp x 2 bsp
00014	3/8 bsp x 3/8 bsp
00015	3/8 bsp x 1/2 bsp
00016	3/8 bsp x 5/8 bsp
00017	3/8 bsp x 3/4 bsp
00018	3/8 bsp x 1 bsp
00019	3/8 bsp x 1-1/4 bsp
00020	3/8 bsp x 1-1/2 bsp
00060	3/8 bsp x 2 bsp
00021	1/2 bsp x 1/2 bsp
00022	1/2 bsp x 5/8 bsp
00023	1/2 bsp x 3/4 bsp
00024	1/2 bsp x 1 bsp
00025	1/2 bsp x 1-1/4 bsp
00026	1/2 bsp x 1-1/2 bsp
00027	1/2 bsp x 2 bsp
00028	5/8 bsp x 5/8 bsp
00029	5/8 bsp x 3/4 bsp
00030	5/8 bsp x 1 bsp
00031	5/8 bsp x 1-1/4 bsp
00069	5/8 bsp x 1-1/2 bsp
00032	3/4 bsp x 3/4 bsp
00033	3/4 bsp x 1 bsp
00034	3/4 bsp x 1-1/4 bsp
00035	3/4 bsp x 1-1/2 bsp

Code	Description
00036	3/4 bsp x 2 bsp
00037	1 bsp x 1 bsp
00038	1 bsp x 1-1/4 bsp
00039	1 bsp x 1-1/2 bsp
00040	1 bsp x 2 bsp
00051	1 bsp x 2-1/2 bsp
00042	1-1/4 bsp x 1-1/4 bsp
00043	1-1/4 bsp x 1-1/2 bsp
00044	1-1/4 bsp x 2 bsp
00041	1-1/4 bsp x 2-1/2 bsp
00045	1-1/2 bsp x 1-1/2 bsp
00046	1-1/2 bsp x 1-3/4 bsp
00047	1-1/2 bsp x 2 bsp
00048	1-1/2 bsp x 2-1/2 bsp
00057	1-3/4 bsp x 1-3/4 bsp
00049	1-3/4 bsp x 2 bsp
00058	1-3/4 bsp x 2-1/2 bsp
00050	2 bsp x 2 bsp
00053	2 bsp x 2-1/2 bsp
00056	2 bsp x 3 bsp
00063	2 bsp x 4 bsp
00052	2-1/2 bsp x 2-1/2 bsp
00054	2-1/2 bsp x 3 bsp
00055	3 bsp x 3 bsp
00065	3 bsp x 3-1/2 bsp
00064	3 bsp x 4 bsp
00061	3-1/2 bsp x 4 bsp
00062	4 bsp x 4 bsp

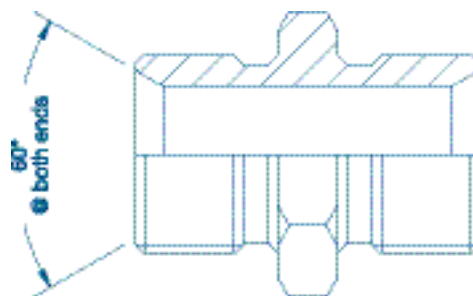

BSP male x BSP male flat faced full thread both ends

Code	Description
20005	1/4 bsp x 1/4 bsp
20014	3/8 bsp x 3/8 bsp
20021	1/2 bsp x 1/2 bsp
20023	1/2 bsp x 3/4 bsp
20032	3/4 bsp x 3/4 bsp
20037	1 bsp x 1 bsp

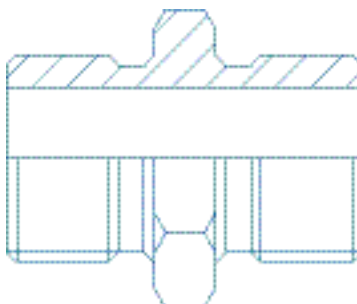

BSP male x BSP male to DIN 3852 Form A

Code	Description
09900	1/8 bsp x 1/8 bsp
09901	1/8 bsp x 1/4 bsp
09902	1/8 bsp x 3/8 bsp
09904	1/4 bsp x 1/4 bsp
09906	1/4 bsp x 3/8 bsp
09907	1/4 bsp x 1/2 bsp
09914	3/8 bsp x 3/8 bsp
09915	3/8 bsp x 1/2 bsp
09918	3/8 bsp x 5/8 bsp
09916	3/8 bsp x 3/4 bsp
09919	3/8 bsp x 1-1/4 bsp
09920	3/8 bsp x 1-1/2 bsp
09921	1/2 bsp x 1/2 bsp
09922	1/2 bsp x 5/8 bsp
09923	1/2 bsp x 3/4 bsp
09924	1/2 bsp x 1 bsp
09928	5/8 bsp x 5/8 bsp
09929	5/8 bsp x 3/4 bsp
09932	3/4 bsp x 3/4 bsp
09933	3/4 bsp x 1 bsp
09934	3/4 bsp x 1-1/4 bsp

Code	Description
09937	1 bsp x 1 bsp
09938	1 bsp x 1-1/4 bsp
09939	1 bsp x 1-1/2 bsp
09941	1-1/4 bsp x 1-1/4 bsp
09942	1-1/4 bsp x 1-1/2 bsp
09945	1-1/2 bsp x 1-1/2 bsp
09947	1-1/2 bsp x 2 bsp
09951	2 bsp x 2 bsp
09953	2 bsp x 2-1/2 bsp

Other sizes in this range may be available on request.

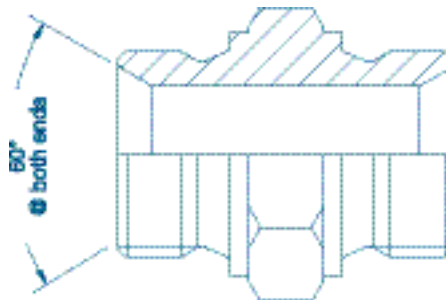

BSP male x BSP male 174 spec

Code	Description
00121	1/8 bsp x 1/8 bsp
00100	1/8 bsp x 1/4 bsp
00114	1/4 bsp x 1/4 bsp
00117	1/4 bsp x 3/8 bsp
00101	1/4 bsp x 1/2 bsp
00120	3/8 bsp x 3/8 bsp
00102	3/8 bsp x 1/2 bsp
00103	3/8 bsp x 3/4 bsp
00126	3/8 bsp x 1 bsp
00125	1/2 bsp x 1/2 bsp
00124	1/2 bsp x 5/8 bsp
00104	1/2 bsp x 3/4 bsp
00116	1/2 bsp x 1 bsp
00105	5/8 bsp x 5/8 bsp
00127	5/8 bsp x 3/4 bsp
00115	3/4 bsp x 3/4 bsp
00106	3/4 bsp x 1 bsp
00107	3/4 bsp x 1-1/4 bsp
00122	3/4 bsp x 1-1/2 bsp

Code	Description
00118	1 bsp x 1 bsp
00119	1 bsp x 1-1/4 bsp
00108	1 bsp x 1-1/2 bsp
00128	1 bsp x 2 bsp
00109	1-1/4 bsp x 1-1/4 bsp
00110	1-1/4 bsp x 1-1/2 bsp
00129	1-1/4 bsp x 2 bsp
00111	1-1/2 bsp x 1-1/2 bsp
00112	1-1/2 bsp x 2 bsp
00113	2 bsp x 2 bsp

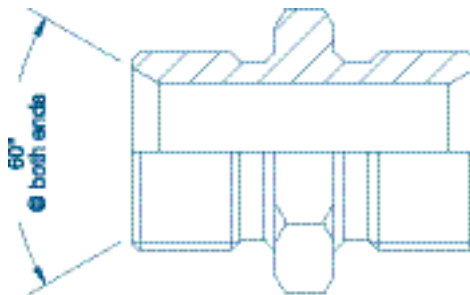

BSP male x BSP male BS5200 spec

Code	Description
5200-04-04	1/4 bsp x 1/4 bsp
5200-04-06	1/4 bsp x 3/8 bsp
5200-06-06	3/8 bsp x 3/8 bsp
5200-06-08	3/8 bsp x 1/2 bsp
5200-08-08	1/2 bsp x 1/2 bsp
5200-12-12	3/4 bsp x 3/4 bsp

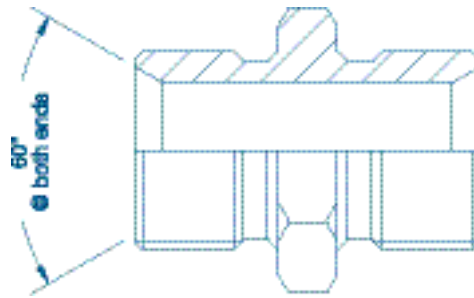

BSP male 3869 SEAL x BSP male

Code	Description
00005-3869	1/4 bsp3869 x 1/4 bsp
00014-3869	3/8 bsp3869 x 3/8 bsp
00021-3869	1/2 bsp3869 x 1/2 bsp
00023-3869	3/4 bsp3869 x 1/2 bsp

Complete with seal.

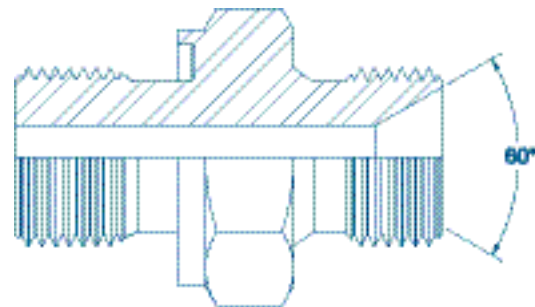

BSP male x BSP male bulkhead LESS LOCKNUT

Code	Description
00200	1/8 bsp
00201	1/4 bsp
00202	3/8 bsp
00203	1/2 bsp
00204	5/8 bsp
00205	3/4 bsp
00206	1 bsp
00207	1-1/4 bsp
00208	1-1/2 bsp
00209	2 bsp
00216	2-1/2 bsp
00217	3 bsp
00212	1/4 bsp x 3/8 bsp
00223	1/4 bsp x 1/2 bsp
00213	3/8 bsp x 1/4 bsp
00211	3/8 bsp x 1/2 bsp
00210	1/2 bsp x 3/8 bsp
00222	1/2 bsp x 5/8 bsp
00214	1/2 bsp x 3/4 bsp
00215	3/4 bsp x 1/2 bsp
00219	3/4 bsp x 1 bsp
00220	1 bsp x 3/4 bsp
00218	1 bsp x 1-1/4 bsp
00224	1-1/4 bsp x 1-1/2 bsp
00221	1-1/2 bsp x 1 bsp

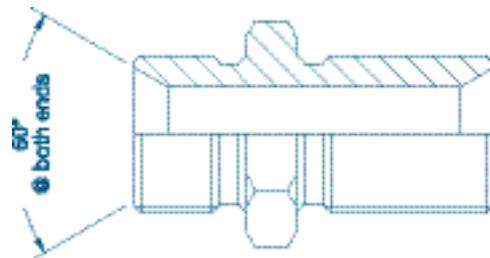

BSP Locknut

Code	Description
00250	1/8 bsp
00251	1/4 bsp
00252	3/8 bsp
00253	1/2 bsp
00254	5/8 bsp
00255	3/4 bsp
00256	1 bsp
00257	1-1/4 bsp

Code	Description
00258	1-1/2 bsp
00259	2 bsp
00260	2-1/2 bsp
00261	3 bsp



BSP male x BSP male bulkhead WITH LOCKNUT

Code	Description
09500	1/8 bsp
09501	1/4 bsp
09502	3/8 bsp
09503	1/2 bsp
09504	5/8 bsp
09506	3/4 bsp
09507	1 bsp
09508	1-1/4 bsp
09509	1-1/2 bsp
09510	2 bsp
09516	2-1/2 bsp
09517	3 bsp

Code	Description
09512	1/4 bsp x 3/8 bsp
09523	1/4 bsp x 1/2 bsp
09513	3/8 bsp x 1/4 bsp
09505	3/8 bsp x 1/2 bsp
09511	1/2 bsp x 3/8 bsp
09519	1/2 bsp x 5/8 bsp
09514	1/2 bsp x 3/4 bsp
09515	3/4 bsp x 1/2 bsp
09518	3/4 bsp x 1 bsp
09520	1 bsp x 1-1/4 bsp
09524	1-1/4 bsp x 1-1/2 bsp
09521	1-1/2 bsp x 1 bsp

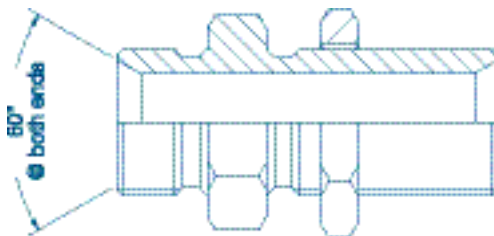

BSP male x BSP male extended bulkhead WITH LOCKNUT

Code	Description	A
12201	1/4 bsp	1.790"
12202	3/8 bsp	1.850"
12203	1/2 bsp	2.030"
12205	5/8 bsp	2.070"
12204	3/4 bsp	2.250"
12206	1 bsp	2.560"
12216	1-1/2 bsp	2.570"
12217	2 bsp	2.570"

Code	Description	A
12211	3/8 bsp x 1/2 bsp	2.030"
12210	1/2 bsp x 3/8 bsp	1.850"
12215	3/4 bsp x 1/2 bsp	2.030"

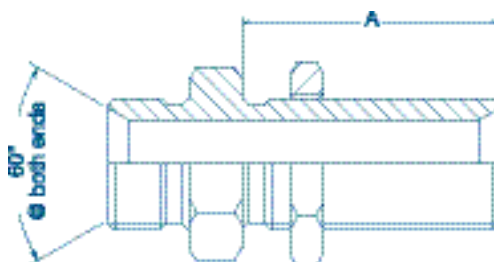

BSP male x BSP male extended bulkhead LESS LOCKNUT

Code	Description	A
00240	1/4 bsp	1.790"
00241	3/8 bsp	1.850"
00242	1/2 bsp	2.030"
00245	5/8 bsp	2.070"
00243	3/4 bsp	2.250"
00244	1 bsp	2.560"
00246	1-1/2 bsp	2.570"
00239	2 bsp	2.570"

Code	Description	A
00248	3/8 bsp x 1/2 bsp	2.030"
00247	1/2 bsp x 3/8 bsp	1.850"
00249	3/4 bsp x 1/2 bsp	2.030"

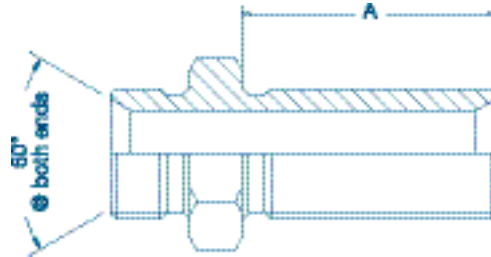

BSP male x BSPT male

Code	Description
00301	1/8 bsp x 1/8 bspt
00302	1/8 bsp x 1/4 bspt
00303	1/8 bsp x 3/8 bspt
00304	1/8 bsp x 1/2 bspt
00305	1/4 bsp x 1/8 bspt
00306	1/4 bsp x 1/4 bspt
00307	1/4 bsp x 3/8 bspt
00308	1/4 bsp x 1/2 bspt
00310	1/4 bsp x 3/4 bspt
00311	3/8 bsp x 1/8 bspt
00312	3/8 bsp x 1/4 bspt
00313	3/8 bsp x 3/8 bspt
00314	3/8 bsp x 1/2 bspt
00315	3/8 bsp x 5/8 bspt
00316	3/8 bsp x 3/4 bspt
00317	3/8 bsp x 1 bspt
00318	1/2 bsp x 1/8 bspt
00319	1/2 bsp x 1/4 bspt
00320	1/2 bsp x 3/8 bspt
00321	1/2 bsp x 1/2 bspt
00322	1/2 bsp x 5/8 bspt
00323	1/2 bsp x 3/4 bspt
00324	1/2 bsp x 1 bspt
00360	1/2 bsp x 1-1/4 bspt
00325	5/8 bsp x 1/4 bspt
00326	5/8 bsp x 3/8 bspt
00327	5/8 bsp x 1/2 bspt
00328	5/8 bsp x 5/8 bspt
00329	5/8 bsp x 3/4 bspt
00330	3/4 bsp x 1/4 bspt
00331	3/4 bsp x 3/8 bspt
00332	3/4 bsp x 1/2 bspt
00333	3/4 bsp x 5/8 bspt
00334	3/4 bsp x 3/4 bspt
00335	3/4 bsp x 1 bspt
00336	3/4 bsp x 1-1/4 bspt
00365	3/4 bsp x 1-1/2 bspt
00367	3/4 bsp x 2 bspt

Code	Description
00337	1 bsp x 1/4 bspt
00361	1 bsp x 3/8 bspt
00338	1 bsp x 1/2 bspt
00339	1 bsp x 3/4 bspt
00340	1 bsp x 1 bspt
00341	1 bsp x 1-1/4 bspt
00342	1 bsp x 1-1/2 bspt
00343	1 bsp x 2 bspt
00344	1-1/4 bsp x 3/4 bspt
00345	1-1/4 bsp x 1 bspt
00346	1-1/4 bsp x 1-1/4 bspt
00347	1-1/4 bsp x 1-1/2 bspt
00348	1-1/4 bsp x 2 bspt
00349	1-1/2 bsp x 1 bspt
00350	1-1/2 bsp x 1-1/4 bspt
00351	1-1/2 bsp x 1-1/2 bspt
00352	1-1/2 bsp x 2 bspt
00353	2 bsp x 1 bspt
00354	2 bsp x 1-1/4 bspt
00355	2 bsp x 1-1/2 bspt
00356	2 bsp x 2 bspt
00363	2 bsp x 2-1/2 bspt
00362	2 bsp x 3 bspt
00359	2-1/2 bsp x 2 bspt
00357	2-1/2 bsp x 2-1/2 bspt
00364	2-1/2 bsp x 3 bspt
00369	3 bsp x 2-1/2 bspt
00358	3 bsp x 3 bspt
00366	4 bsp x 4 bspt

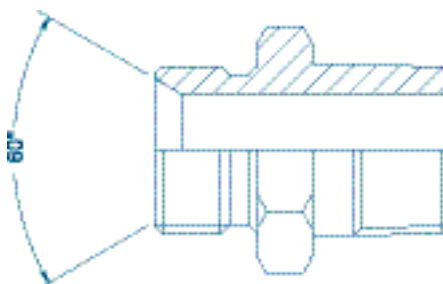

BSP male DIN 3852 FORM A x BSPT male

Code	Description
60001	1/8 bsp x 1/8 bspt
60002	1/8 bsp x 1/4 bspt
60003	1/8 bsp x 3/8 bspt
60004	1/8 bsp x 1/2 bspt
60005	1/4 bsp x 1/8 bspt
60006	1/4 bsp x 1/4 bspt
60007	1/4 bsp x 3/8 bspt
60008	1/4 bsp x 1/2 bspt
60009	1/4 bsp x 3/4 bspt
60010	3/8 bsp x 1/8 bspt
60011	3/8 bsp x 1/4 bspt
60012	3/8 bsp x 3/8 bspt
60013	3/8 bsp x 1/2 bspt
60015	3/8 bsp x 3/4 bspt
60016	3/8 bsp x 1 bspt
60017	1/2 bsp x 1/8 bspt
60018	1/2 bsp x 1/4 bspt
60019	1/2 bsp x 3/8 bspt
60020	1/2 bsp x 1/2 bspt
60022	1/2 bsp x 3/4 bspt
60023	1/2 bsp x 1 bspt
60024	1/2 bsp x 1-1/4 bspt
60030	3/4 bsp x 1/4 bspt
60031	3/4 bsp x 3/8 bspt
60032	3/4 bsp x 1/2 bspt
60034	3/4 bsp x 3/4 bspt
60035	3/4 bsp x 1 bspt
60036	3/4 bsp x 1-1/4 bspt
60037	3/4 bsp x 1-1/2 bspt
60038	1 bsp x 3/8 bspt
60039	1 bsp x 1/2 bspt
60040	1 bsp x 3/4 bspt
60041	1 bsp x 1 bspt
60042	1 bsp x 1-1/4 bspt
60043	1 bsp x 1-1/2 bspt
60044	1 bsp x 2 bspt
60045	1-1/4 bsp x 3/4 bspt
60046	1-1/4 bsp x 1 bspt
60047	1-1/4 bsp x 1-1/4 bspt
60048	1-1/4 bsp x 1-1/2 bspt
60049	1-1/4 bsp x 2 bspt
60050	1-1/2 bsp x 1 bspt
60051	1-1/2 bsp x 1-1/4 bspt
60052	1-1/2 bsp x 1-1/2 bspt
60053	1-1/2 bsp x 2 bspt
60054	2 bsp x 1 bspt
60055	2 bsp x 1-1/4 bspt
60056	2 bsp x 1-1/2 bspt
60057	2 bsp x 2 bspt

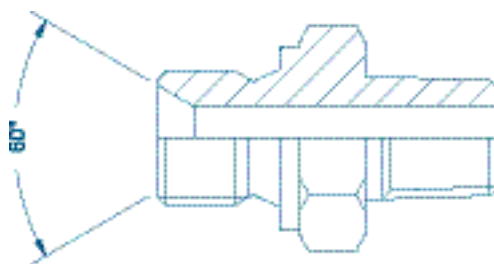

BSP male x JIC male

Code	Description
01164	1/8 bsp x 3/8 jic
01101	1/8 bsp x 7/16 jic
01102	1/8 bsp x 1/2 jic
01100	1/8 bsp x 9/16 jic
01160	1/4 bsp x 5/16 jic
01163	1/4 bsp x 3/8 jic
01103	1/4 bsp x 7/16 jic
01104	1/4 bsp x 1/2 jic
01105	1/4 bsp x 9/16 jic
01106	1/4 bsp x 3/4 jic
01107	1/4 bsp x 7/8 jic
01155	1/4 bsp x 1-1/16 jic
01168	1/4 bsp x 1-3/16 jic
01108	1/4 bsp x 1-5/16 jic
01109	3/8 bsp x 7/16 jic
01110	3/8 bsp x 1/2 jic
01111	3/8 bsp x 9/16 jic
01112	3/8 bsp x 3/4 jic
01113	3/8 bsp x 7/8 jic
01114	3/8 bsp x 1-1/16 jic
01115	3/8 bsp x 1-5/16 jic
01116	1/2 bsp x 7/16 jic
01117	1/2 bsp x 1/2 jic
01118	1/2 bsp x 9/16 jic
01119	1/2 bsp x 3/4 jic
01120	1/2 bsp x 7/8 jic
01121	1/2 bsp x 1-1/16 jic
01174	1/2 bsp x 1-3/16 jic
01122	1/2 bsp x 1-5/16 jic
01180	5/8 bsp x 7/16 jic
01181	5/8 bsp x 1/2 jic
01123	5/8 bsp x 9/16 jic
01124	5/8 bsp x 3/4 jic
01125	5/8 bsp x 7/8 jic
01126	5/8 bsp x 1-1/16 jic
01127	5/8 bsp x 1-3/16 jic
01128	5/8 bsp x 1-5/16 jic
01182	5/8 bsp x 1-5/8 jic
01129	3/4 bsp x 7/16 jic
01130	3/4 bsp x 1/2 jic
01150	3/4 bsp x 9/16 jic
01131	3/4 bsp x 3/4 jic
01132	3/4 bsp x 7/8 jic
01133	3/4 bsp x 1-1/16 jic
01134	3/4 bsp x 1-3/16 jic
01135	3/4 bsp x 1-5/16 jic
01148	3/4 bsp x 1-5/8 jic
01158	3/4 bsp x 1-7/8 jic

Code	Description
01169	1 bsp x 9/16 jic
01136	1 bsp x 3/4 jic
01137	1 bsp x 7/8 jic
01138	1 bsp x 1-1/16 jic
01139	1 bsp x 1-3/16 jic
01140	1 bsp x 1-5/16 jic
01141	1 bsp x 1-5/8 jic
01156	1 bsp x 1-7/8 jic
01151	1 bsp x 2-1/2 jic
01142	1-1/4 bsp x 1-1/16 jic
01143	1-1/4 bsp x 1-5/16 jic
01144	1-1/4 bsp x 1-5/8 jic
01145	1-1/4 bsp x 1-7/8 jic
01152	1-1/4 bsp x 2-1/2 jic
01159	1-1/2 bsp x 1-1/16 jic
01149	1-1/2 bsp x 1-5/16 jic
01154	1-1/2 bsp x 1-5/8 jic
01146	1-1/2 bsp x 1-7/8 jic
01153	1-1/2 bsp x 2-1/2 jic
01162	2 bsp x 1-5/16 jic
01175	2 bsp x 1-5/8 jic
01157	2 bsp x 1-7/8 jic
01147	2 bsp x 2-1/2 jic
01179	2-1/2 bsp x 1-7/8 jic
01165	3 bsp x 1-7/8 jic
01166	3 bsp x 2-1/2 jic
01167	3-1/2 bsp x 2-1/2 jic

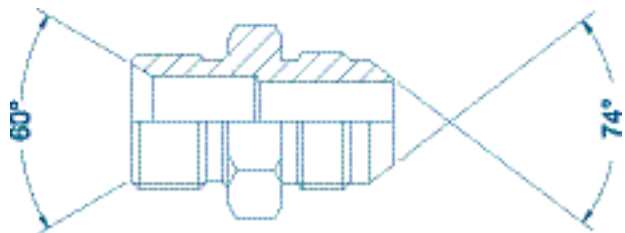

BSP male DIN 3852 FORM A x JIC male

Code	Description
61164	1/8 bsp x 3/8 jic
61101	1/8 bsp x 7/16 jic
61102	1/8 bsp x 1/2 jic
61100	1/8 bsp x 9/16 jic
61160	1/4 bsp x 5/16 jic
61163	1/4 bsp x 3/8 jic
61103	1/4 bsp x 7/16 jic
61104	1/4 bsp x 1/2 jic
61105	1/4 bsp x 9/16 jic
61106	1/4 bsp x 3/4 jic
61107	1/4 bsp x 7/8 jic
61155	1/4 bsp x 1-1/16 jic
61168	1/4 bsp x 1-3/16 jic
61108	1/4 bsp x 1-5/16 jic
61170	3/8 bsp x 3/8 jic
61109	3/8 bsp x 7/16 jic
61110	3/8 bsp x 1/2 jic
61111	3/8 bsp x 9/16 jic
61112	3/8 bsp x 3/4 jic
61113	3/8 bsp x 7/8 jic
61114	3/8 bsp x 1-1/16 jic
61171	3/8 bsp x 1-3/16 jic
61115	3/8 bsp x 1-5/16 jic
61116	1/2 bsp x 7/16 jic
61117	1/2 bsp x 1/2 jic
61118	1/2 bsp x 9/16 jic
61119	1/2 bsp x 3/4 jic
61120	1/2 bsp x 7/8 jic
61121	1/2 bsp x 1-1/16 jic
61122	1/2 bsp x 1-5/16 jic
61161	1/2 bsp x 1-7/8 jic
61123	5/8 bsp x 9/16 jic
61124	5/8 bsp x 3/4 jic
61125	5/8 bsp x 7/8 jic
61126	5/8 bsp x 1-1/16 jic
61127	5/8 bsp x 1-3/16 jic
61128	5/8 bsp x 1-5/16 jic
61129	3/4 bsp x 7/16 jic
61130	3/4 bsp x 1/2 jic
61150	3/4 bsp x 9/16 jic
61131	3/4 bsp x 3/4 jic
61132	3/4 bsp x 7/8 jic
61133	3/4 bsp x 1-1/16 jic
61134	3/4 bsp x 1-3/16 jic
61135	3/4 bsp x 1-5/16 jic
61148	3/4 bsp x 1-5/8 jic
61158	3/4 bsp x 1-7/8 jic

Code	Description
61169	1 bsp x 9/16 jic
61136	1 bsp x 3/4 jic
61137	1 bsp x 7/8 jic
61138	1 bsp x 1-1/16 jic
61139	1 bsp x 1-3/16 jic
61140	1 bsp x 1-5/16 jic
61141	1 bsp x 1-5/8 jic
61156	1 bsp x 1-7/8 jic
61151	1 bsp x 2-1/2 jic
61142	1-1/4 bsp x 1-1/16 jic
61143	1-1/4 bsp x 1-5/16 jic
61144	1-1/4 bsp x 1-5/8 jic
61145	1-1/4 bsp x 1-7/8 jic
61152	1-1/4 bsp x 2-1/2 jic
61159	1-1/2 bsp x 1-1/16 jic
61149	1-1/2 bsp x 1-5/16 jic
61154	1-1/2 bsp x 1-5/8 jic
61146	1-1/2 bsp x 1-7/8 jic
61153	1-1/2 bsp x 2-1/2 jic
61162	2 bsp x 1-5/16 jic
61157	2 bsp x 1-7/8 jic
61147	2 bsp x 2-1/2 jic
61165	3 bsp x 1-7/8 jic
61166	3 bsp x 2-1/2 jic
61167	3-1/2 bsp x 2-1/2 jic

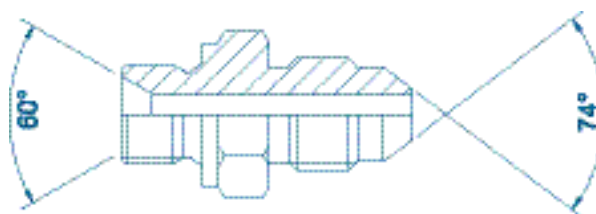

BSP male 3869 SEAL x JIC male

Code	Description
01111-3869	3/8 bsp3869 x 9/16 jic
01132-3869	3/4 bsp3869 x 7/8 bsp

Complete with seal.

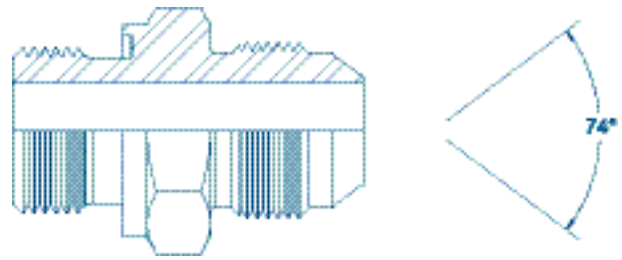

BSP male x SAE male 45° external flare

Code	Description
13200	3/8 bsp x 5/8 sae
13201	3/8 bsp x 1-1/16 sae

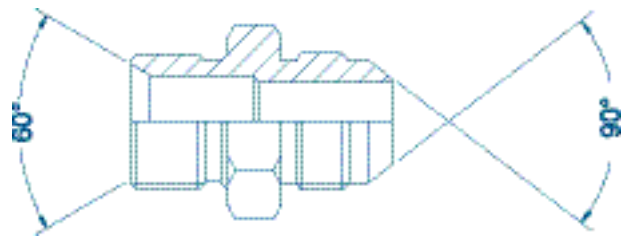

BSPT male x BSPT male

Code	Description
00410	1/8 bspt x 1/8 bspt
00412	1/8 bspt x 1/4 bspt
00400	1/8 bspt x 3/8 bspt
00401	1/4 bspt x 1/4 bspt
00414	1/4 bspt x 3/8 bspt
00411	1/4 bspt x 1/2 bspt
00402	3/8 bspt x 3/8 bspt
00403	3/8 bspt x 1/2 bspt
00404	1/2 bspt x 1/2 bspt
00398	1/2 bspt x 5/8 bspt
00417	1/2 bspt x 3/4 bspt
00415	5/8 bspt x 5/8 bspt
00405	3/4 bspt x 3/4 bspt
00416	3/4 bspt x 1 bspt
00423	3/4 bspt x 1-1/4 bspt
00406	1 bspt x 1 bspt
00424	1 bspt x 1-1/4 bspt
00413	1 bspt x 1-1/2 bspt
00407	1-1/4 bspt x 1-1/4 bspt
00419	1-1/4 bspt x 1-1/2 bspt
00421	1-1/4 bspt x 2 bspt
00408	1-1/2 bspt x 1-1/2 bspt
00422	1-1/2 bspt x 2 bspt
00397	1-1/2 bspt x 2-1/2 bspt
00409	2 bspt x 2 bspt
00399	2 bspt x 2-1/2 bspt
00396	2 bspt x 3 bspt
00418	2-1/2 bspt x 2-1/2 bspt
00420	3 bspt x 3 bspt

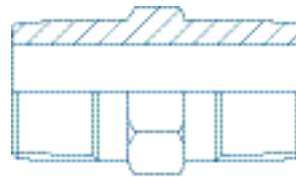

BSPT male x NPTF male

Code	Description
10016	1/8 bspt x 1/8 nptf
10012	1/8 bspt x 1/4 nptf
10013	1/4 bspt x 1/8 nptf
10000	1/4 bspt x 1/4 nptf
10008	1/4 bspt x 3/8 nptf
10033	1/4 bspt x 3/4 nptf
10009	3/8 bspt x 1/4 nptf
10001	3/8 bspt x 3/8 nptf
10017	3/8 bspt x 1/2 nptf
10032	3/8 bspt x 3/4 nptf
10002	1/2 bspt x 1/2 nptf
10022	1/2 bspt x 3/4 nptf
10003	3/4 bspt x 3/4 nptf
10015	3/4 bspt x 1 nptf
10018	1 bspt x 3/4 nptf
10004	1 bspt x 1 nptf
10027	1 bspt x 1-1/4 nptf
10020	1 bspt x 2 nptf
10031	1-1/4 bspt x 1 nptf
10005	1-1/4 bspt x 1-1/4 nptf

Code	Description
10030	1-1/2 bspt x 1 nptf
10011	1-1/2 bspt x 1-1/4 nptf
10006	1-1/2 bspt x 1-1/2 nptf
10023	1-1/2 bspt x 2 nptf
10019	2 bspt x 1 nptf
10014	2 bspt x 1-1/2 nptf
10007	2 bspt x 2 nptf
10026	2-1/2 bspt x 2 nptf
10010	2-1/2 bspt x 2-1/2 nptf
10025	3 bspt x 2 nptf
10021	3 bspt x 3 nptf
10024	4 bspt x 4 nptf

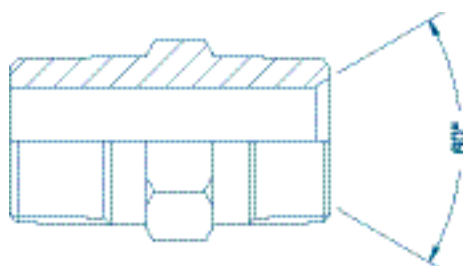

BSPT male x JIC male

Code	Description
19300	1/8 bspt x 7/16 jic
19302	1/8 bspt x 1/2 jic
19301	1/8 bspt x 9/16 jic
19303	1/4 bspt x 7/16 jic
19305	1/4 bspt x 1/2 jic
19304	1/4 bspt x 9/16 jic
19317	1/4 bspt x 3/4 jic
19338	1/4 bspt x 7/8 jic
19306	3/8 bspt x 7/16 jic
19318	3/8 bspt x 1/2 jic
19307	3/8 bspt x 9/16 jic
19308	3/8 bspt x 3/4 jic
19319	3/8 bspt x 7/8 jic
19309	1/2 bspt x 9/16 jic
19311	1/2 bspt x 3/4 jic
19310	1/2 bspt x 7/8 jic
19312	1/2 bspt x 1-1/16 jic
19320	3/4 bspt x 3/4 jic
19321	3/4 bspt x 7/8 jic
19313	3/4 bspt x 1-1/16 jic
19314	3/4 bspt x 1-3/16 jic
19322	3/4 bspt x 1-5/16 jic

Code	Description
19323	1 bspt x 3/4 jic
19330	1 bspt x 7/8 jic
19315	1 bspt x 1-1/16 jic
19316	1 bspt x 1-5/16 jic
19327	1 bspt x 1-5/8 jic
19329	1-1/4 bspt x 1-5/16 jic
19324	1-1/4 bspt x 1-5/8 jic
19333	1-1/4 bspt x 1-7/8 jic
19328	1-1/2 bspt x 1-5/8 jic
19325	1-1/2 bspt x 1-7/8 jic
19331	2 bspt x 1-7/8 jic
19326	2 bspt x 2-1/2 jic

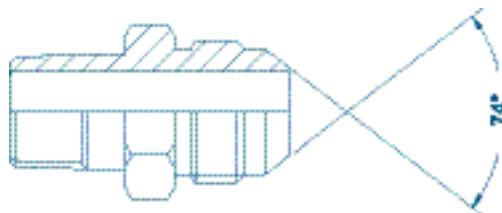

BSPT male x SAE male 45° external flare

Code	Description
18053	1/8 bspt x 5/8 sae
18050	1/4 bspt x 5/8 sae
18051	3/8 bspt x 5/8 sae
18052	1/2 bspt x 5/8 sae

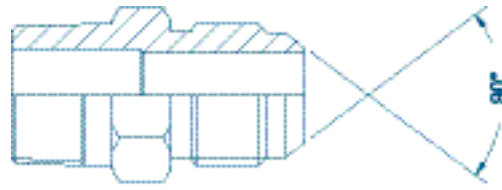

NPTF male x NPTF male

Code	Description
00675	1/8 nptf x 1/8 nptf
00676	1/8 nptf x 1/4 nptf
00700	1/8 nptf x 3/8 nptf
00704	1/8 nptf x 1/2 nptf
00677	1/4 nptf x 1/4 nptf
00678	1/4 nptf x 3/8 nptf
00681	1/4 nptf x 1/2 nptf
00684	1/4 nptf x 3/4 nptf
00699	1/4 nptf x 1 nptf
00679	3/8 nptf x 3/8 nptf
00680	3/8 nptf x 1/2 nptf
00685	3/8 nptf x 3/4 nptf
00708	3/8 nptf x 1 nptf
00682	1/2 nptf x 1/2 nptf
00686	1/2 nptf x 3/4 nptf
00690	1/2 nptf x 1 nptf
00705	1/2 nptf x 1-1/4 nptf
00702	1/2 nptf x 1-1/2 nptf
00688	3/4 nptf x 3/4 nptf
00691	3/4 nptf x 1 nptf
00689	3/4 nptf x 1-1/4 nptf
00695	3/4 nptf x 1-1/2 nptf
00692	1 nptf x 1 nptf
00693	1 nptf x 1-1/4 nptf
00701	1 nptf x 1-1/2 nptf
00712	1 nptf x 2 nptf
00694	1-1/4 nptf x 1-1/4 nptf
00696	1-1/4 nptf x 1-1/2 nptf
00706	1-1/4 nptf x 2 nptf
00697	1-1/2 nptf x 1-1/2 nptf
00703	1-1/2 nptf x 2 nptf
00714	1-1/2 nptf x 3 nptf
00698	2 nptf x 2 nptf
00717	2 nptf x 2-1/2 nptf
00711	2 nptf x 3 nptf
00707	2-1/2 nptf x 2-1/2 nptf
00713	2-1/2 nptf x 3 nptf
00709	3 nptf x 3 nptf
00710	4 nptf x 4 nptf

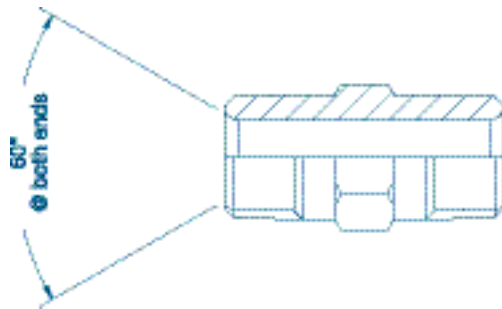

NPTF male x BSP male

Code	Description
00600	1/8 nptf x 1/8 bsp
00601	1/8 nptf x 1/4 bsp
00602	1/8 nptf x 3/8 bsp
00603	1/8 nptf x 1/2 bsp
00604	1/4 nptf x 1/8 bsp
00605	1/4 nptf x 1/4 bsp
00606	1/4 nptf x 3/8 bsp
00607	1/4 nptf x 1/2 bsp
00608	1/4 nptf x 3/4 bsp
00650	1/4 nptf x 1 bsp
00609	3/8 nptf x 1/8 bsp
00610	3/8 nptf x 1/4 bsp
00611	3/8 nptf x 3/8 bsp
00612	3/8 nptf x 1/2 bsp
00613	3/8 nptf x 5/8 bsp
00614	3/8 nptf x 3/4 bsp
00660	3/8 nptf x 1 bsp
00656	1/2 nptf x 1/8 bsp
00615	1/2 nptf x 1/4 bsp
00616	1/2 nptf x 3/8 bsp
00617	1/2 nptf x 1/2 bsp
00618	1/2 nptf x 5/8 bsp
00619	1/2 nptf x 3/4 bsp
00620	1/2 nptf x 1 bsp
00621	3/4 nptf x 1/4 bsp
00622	3/4 nptf x 3/8 bsp
00623	3/4 nptf x 1/2 bsp
00624	3/4 nptf x 5/8 bsp
00625	3/4 nptf x 3/4 bsp
00626	3/4 nptf x 1 bsp
00627	3/4 nptf x 1-1/4 bsp
00647	3/4 nptf x 1-1/2 bsp
00628	1 nptf x 1/4 bsp
00649	1 nptf x 3/8 bsp
00629	1 nptf x 1/2 bsp
00630	1 nptf x 3/4 bsp
00631	1 nptf x 1 bsp
00632	1 nptf x 1-1/4 bsp
00633	1 nptf x 1-1/2 bsp
00634	1 nptf x 2 bsp
00635	1-1/4 nptf x 3/4 bsp
00636	1-1/4 nptf x 1 bsp
00637	1-1/4 nptf x 1-1/4 bsp
00638	1-1/4 nptf x 1-1/2 bsp
00639	1-1/4 nptf x 2 bsp
00674	1-1/2 nptf x 3/4 bsp
00640	1-1/2 nptf x 1 bsp
00648	1-1/2 nptf x 1-1/4 bsp
00641	1-1/2 nptf x 1-1/2 bsp
00642	1-1/2 nptf x 2 bsp

Code	Description
00673	2 nptf x 3/4 bsp
00643	2 nptf x 1 bsp
00653	2 nptf x 1-1/4 bsp
00644	2 nptf x 1-1/2 bsp
00645	2 nptf x 2 bsp
00646	2 nptf x 2-1/2 bsp
00670	2 nptf x 3 bsp
00657	2-1/2 nptf x 2 bsp
00654	2-1/2 nptf x 2-1/2 bsp
00671	2-1/2 nptf x 3 bsp
00658	3 nptf x 2 bsp
00659	3 nptf x 2-1/2 bsp
00655	3 nptf x 3 bsp
00672	4 nptf x 4 bsp

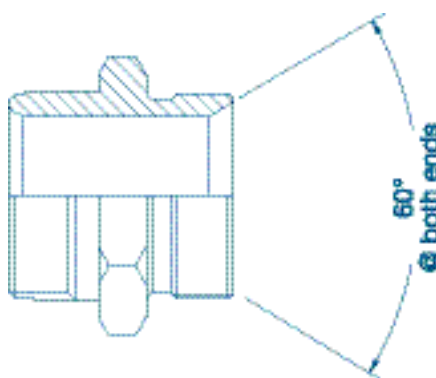

NPTF male x JIC male

Code	Description
00772	1/8 nptf x 3/8 jic
00720	1/8 nptf x 7/16 jic
00721	1/8 nptf x 1/2 jic
00722	1/8 nptf x 9/16 jic
00723	1/8 nptf x 3/4 jic
00742	1/4 nptf x 3/8 jic
00724	1/4 nptf x 7/16 jic
00725	1/4 nptf x 1/2 jic
00726	1/4 nptf x 9/16 jic
00727	1/4 nptf x 3/4 jic
00728	1/4 nptf x 7/8 jic
00743	1/4 nptf x 1-1/16 jic
00744	1/4 nptf x 1-5/16 jic
00729	3/8 nptf x 7/16 jic
00730	3/8 nptf x 1/2 jic
00731	3/8 nptf x 9/16 jic
00732	3/8 nptf x 3/4 jic
00733	3/8 nptf x 7/8 jic
00734	3/8 nptf x 1-1/16 jic
00775	3/8 nptf x 1-5/16 jic
00735	1/2 nptf x 7/16 jic
00736	1/2 nptf x 1/2 jic
00737	1/2 nptf x 9/16 jic
00738	1/2 nptf x 3/4 jic
00739	1/2 nptf x 7/8 jic
00740	1/2 nptf x 1-1/16 jic
00741	1/2 nptf x 1-5/16 jic
00745	3/4 nptf x 7/16 jic
00746	3/4 nptf x 9/16 jic
00747	3/4 nptf x 3/4 jic
00748	3/4 nptf x 7/8 jic
00749	3/4 nptf x 1-1/16 jic
00750	3/4 nptf x 1-5/16 jic
00771	3/4 nptf x 1-5/8 jic
00767	1 nptf x 3/4 jic
00768	1 nptf x 7/8 jic
00751	1 nptf x 1-1/16 jic
00752	1 nptf x 1-5/16 jic
00753	1 nptf x 1-5/8 jic
00754	1 nptf x 1-7/8 jic
00756	1-1/4 nptf x 1-1/16 jic
00757	1-1/4 nptf x 1-5/16 jic
00758	1-1/4 nptf x 1-5/8 jic
00759	1-1/4 nptf x 1-7/8 jic
00760	1-1/4 nptf x 2-1/2 jic
00761	1-1/2 nptf x 1-1/16 jic
00762	1-1/2 nptf x 1-5/16 jic
00763	1-1/2 nptf x 1-5/8 jic
00764	1-1/2 nptf x 1-7/8 jic
00765	1-1/2 nptf x 2-1/2 jic

Code	Description
00770	2 nptf x 1-5/8 jic
00769	2 nptf x 1-7/8 jic
00766	2 nptf x 2-1/2 jic
00755	2-1/2 nptf x 3 jic

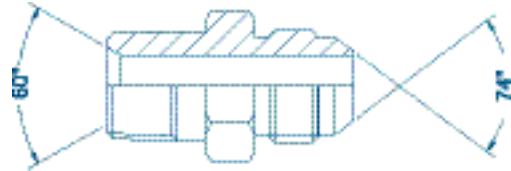

NPTF male x JIC male extended

Code	Description	A
10720	1/8 nptf x 7/16 jic	1.812"
10726	1/4 nptf x 9/16 jic	2.246"
10731	3/8 nptf x 9/16 jic	2.482"
10732	3/8 nptf x 3/4 jic	2.758"
10740	1/2 nptf x 1-1/16 jic	3.270"
10752	1 nptf x 1-5/16 jic	4.018"

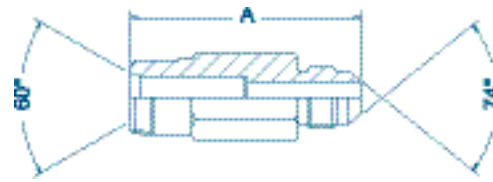

NPTF male x JIC male extended

Code	Description	A
20720	1/8 nptf x 7/16 jic	2.561"
20732	3/8 nptf x 3/4 jic	4.018"

Due to lack of demand, it is no longer economical for us to supply these items and once sold will no longer be available.

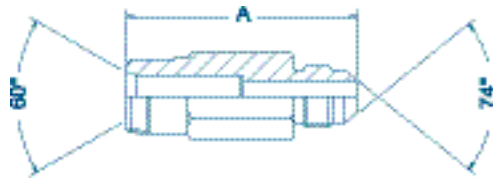

NPTF male x SAE male 45° external flare

Code	Description
01050	1/8 nptf x 7/16 sae
01051	1/8 nptf x 1/2 sae
01052	1/4 nptf x 7/16 sae
01053	1/4 nptf x 1/2 sae
01054	1/4 nptf x 5/8 sae
01055	1/4 nptf x 3/4 sae
01056	3/8 nptf x 7/16 sae
01058	3/8 nptf x 5/8 sae
01057	3/8 nptf x 3/4 sae
01059	3/8 nptf x 7/8 sae
01060	1/2 nptf x 5/8 sae
01061	1/2 nptf x 3/4 sae
01062	1/2 nptf x 7/8 sae
01063	1/2 nptf x 1-1/16 sae
01065	3/4 nptf x 3/4 sae
01066	3/4 nptf x 7/8 sae
01067	3/4 nptf x 1-1/16 sae

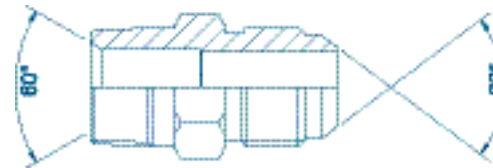

METRIC male x METRIC male 1.5mm pitch

Code	Description
00425	10mm x 10mm
00426	10mm x 12mm
00427	10mm x 14mm
00428	10mm x 16mm
00429	12mm x 12mm
00430	12mm x 14mm
00431	12mm x 16mm
00465	12mm x 18mm
00432	14mm x 14mm
00433	14mm x 16mm
00434	14mm x 18mm
00435	14mm x 20mm
00463	14mm x 22mm
00437	16mm x 16mm
00438	16mm x 18mm
00439	16mm x 20mm
00440	16mm x 22mm
00472	16mm x 24mm
00441	16mm x 26mm
00442	18mm x 18mm
00443	18mm x 20mm
00444	18mm x 22mm
00466	18mm x 24mm
00445	18mm x 26mm
00446	18mm x 30mm
00447	20mm x 20mm
00448	20mm x 22mm
00467	20mm x 24mm
00468	20mm x 26mm
00450	22mm x 22mm
00451	22mm x 24mm
00452	22mm x 26mm
00453	22mm x 30mm
00454	24mm x 24mm
00469	24mm x 26mm

Code	Description
00455	26mm x 26mm
00457	30mm x 30mm
00464	30mm x 38mm
00458	38mm x 38mm

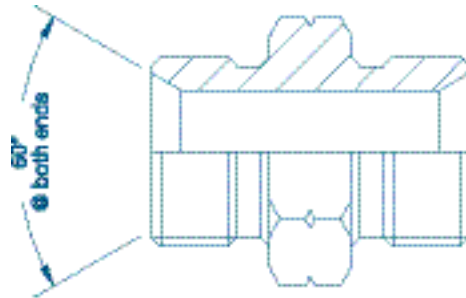

METRIC male x METRIC male 1.5mm pitch bulkhead LESS LOCKNUT

Code	Description
00160	12 mm
00161	14 mm
00162	16 mm
00163	18 mm
00164	20 mm
00165	22 mm
00166	24 mm

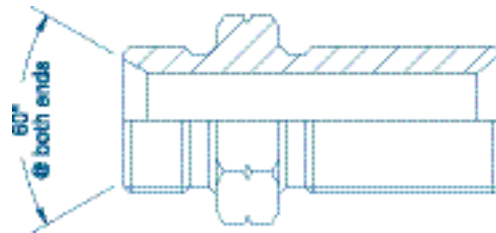

METRIC male x METRIC male 1.5mm pitch bulkhead WITH LOCKNUT

Code	Description
09550	12 mm
09551	14 mm
09552	16 mm
09553	18 mm
09554	20 mm
09555	22 mm
09556	24 mm

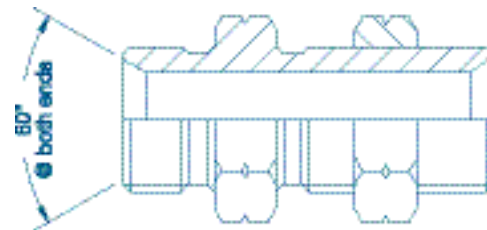

METRIC LOCKNUT by 1.5mm pitch

Code	Description
00290	12 mm
00291	14 mm
00292	16 mm
00293	18 mm
00294	20 mm
00295	22 mm
00296	24 mm

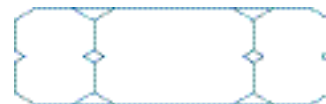

METRIC male 1.5mm pitch x BSP male

Code	Description
00558	10mm x 1/8 bsp
00500	10mm x 1/4 bsp
00546	10mm x 3/8 bsp
00501	12mm x 1/8 bsp
00502	12mm x 1/4 bsp
00503	12mm x 3/8 bsp
00504	12mm x 1/2 bsp
00505	14mm x 1/8 bsp
00506	14mm x 1/4 bsp
00507	14mm x 3/8 bsp
00508	14mm x 1/2 bsp
00549	14mm x 5/8 bsp
00560	16mm x 1/8 bsp
00509	16mm x 1/4 bsp
00510	16mm x 3/8 bsp
00511	16mm x 1/2 bsp
00512	16mm x 5/8 bsp
00513	16mm x 3/4 bsp
00514	18mm x 1/4 bsp
00515	18mm x 3/8 bsp
00516	18mm x 1/2 bsp
00517	18mm x 5/8 bsp
00518	18mm x 3/4 bsp
00519	18mm x 1 bsp
00520	20mm x 1/4 bsp
00521	20mm x 3/8 bsp
00522	20mm x 1/2 bsp
00523	20mm x 3/4 bsp
00524	22mm x 1/4 bsp
00525	22mm x 3/8 bsp
00526	22mm x 1/2 bsp
00527	22mm x 5/8 bsp
00528	22mm x 3/4 bsp
00529	22mm x 1 bsp
00552	22mm x 1-1/2 bsp

Code	Description
00551	24mm x 1/4 bsp
00550	24mm x 3/8 bsp
00530	24mm x 1/2 bsp
00531	24mm x 3/4 bsp
00554	26mm x 3/8 bsp
00532	26mm x 1/2 bsp
00544	26mm x 5/8 bsp
00533	26mm x 3/4 bsp
00534	26mm x 1 bsp
00538	26mm x 1-1/4 bsp
00545	28mm x 1 bsp
00559	30mm x 3/8 bsp
00535	30mm x 3/4 bsp
00536	30mm x 1 bsp
00537	30mm x 1-1/4 bsp
00547	36mm x 1 bsp
00548	38mm x 1 bsp
00539	38mm x 1-1/4 bsp
00540	38mm x 1-1/2 bsp
00541	45mm x 1-1/2 bsp
00542	45mm x 2 bsp
00543	52mm x 2 bsp

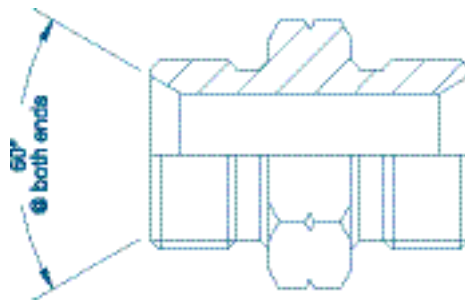

METRIC male 1mm pitch x BSP male

Code	Description
10542	8 mm x 1/8 bsp
10544	10 mm x 1/8 bsp
10545	10 mm x 1/4 bsp
10548	10 mm x 3/8 bsp
10543	12 mm x 1/8 bsp
10546	12 mm x 1/4 bsp
10541	14 mm x 1/4 bsp

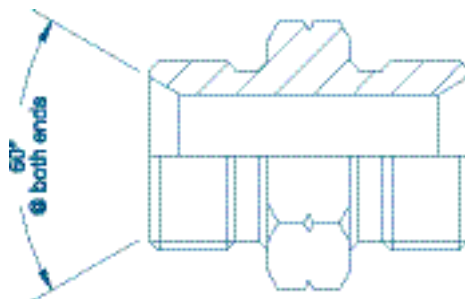

METRIC male 1.5mm pitch x BSP male to DIN 3852 FORM A

Code	Description
60500	22mm x 1/2 bsp

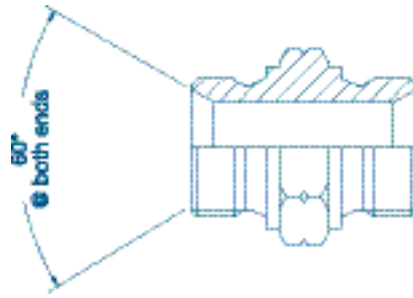

METRIC male 1.5mm pitch x JIC male

Code	Description
01265	10mm x 7/16 jic
01274	12mm x 7/16 jic
01284	12mm x 9/16 jic
01286	12mm x 3/4 jic
01268	14mm x 3/8 jic
01291	14mm x 7/16 jic
01287	14mm x 9/16 jic
01288	14mm x 3/4 jic
01272	14mm x 7/8 jic
01295	16mm x 7/16 jic
01280	16mm x 9/16 jic
01275	16mm x 3/4 jic
01289	16mm x 7/8 jic
01296	16mm x 1-1/16 jic
01299	18mm x 7/16 jic
01276	18mm x 9/16 jic
01281	18mm x 3/4 jic
01283	18mm x 7/8 jic
01298	18mm x 1-1/16 jic
01282	20mm x 9/16 jic
01277	20mm x 3/4 jic
01290	20mm x 7/8 jic
01270	20mm x 1-1/16 jic
01285	22mm x 9/16 jic
01278	22mm x 3/4 jic
01279	22mm x 7/8 jic
01294	22mm x 1-1/16 jic
01293	24mm x 3/4 jic
01267	24mm x 1-1/16 jic
01297	26mm x 7/8 jic
01292	26mm x 1-1/16 jic

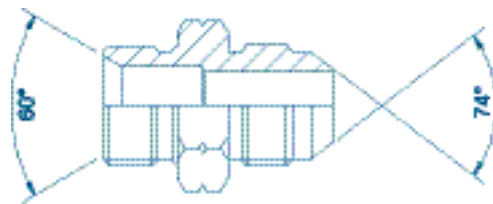

METRIC male 1.5mm pitch 24° cone Tube Fitting x JIC male

Code	Description
41274-6	12mm x 7/16 jic
41291-6	14mm x 7/16 jic
41291-8	14mm x 7/16 jic
41287-8	14mm x 9/16 jic
41295-8	16mm x 7/16 jic
41295-10	16mm x 7/16 jic
41280-8	16mm x 9/16 jic
41280-10	16mm x 9/16 jic
41275-10	16mm x 3/4 jic
41276-10	18mm x 9/16 jic
41276-12	18mm x 9/16 jic
41281-10	18mm x 3/4 jic
41281-12	18mm x 3/4 jic
41282-12	20mm x 9/16 jic
41263-12	20mm x 3/4 jic
41290-12	20mm x 7/8 jic
41278-14	22mm x 3/4 jic
41278-15	22mm x 3/4 jic
41279-15	22mm x 7/8 jic
41294-15	22mm x 1-1/16 jic
41271-16	24mm x 7/8 jic
41272-18	24mm x 1-1/16 jic
41292-18	26mm x 1-1/16 jic
41270-20	30mm x 1-1/16 jic
41270-22	30mm x 1-1/16 jic
41262-28	36mm x 1-1/16 jic
41296-35	45mm x 1-5/16 jic

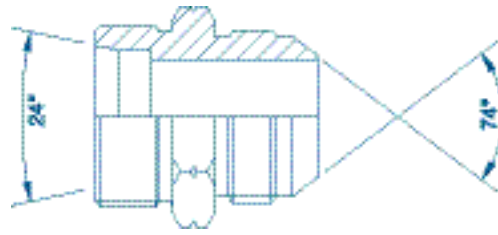

example: **41296** (fitting), **-35** (metric tube size).

METRIC male 2mm pitch 24° cone Tube Fitting x JIC male

Code	Description
41270/2-20	30mm x 1-1/16 jic
41270/2-22	30mm x 1-1/16 jic
41262/2-25	36mm x 1-1/16 jic
41262/2-28	36mm x 1-1/16 jic
41269/2-28	36mm x 1-5/16 jic
41265/2-30	42mm x 1-5/16 jic
41267/2-30	42mm x 1-5/8 jic
41296/2-35	45mm x 1-5/16 jic
41266/2-35	45mm x 1-5/8 jic
41268/2-38	52mm x 1-5/8 jic
41260/2-42	52mm x 1-7/8 jic

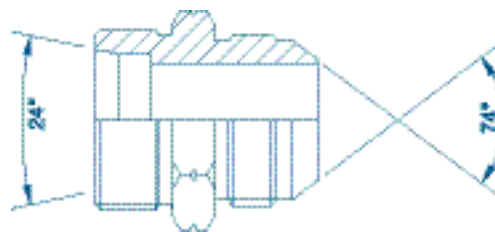

example: **41260** (product), **/2** (thread pitch), **-42** (metric tube size).

JIC male x JIC male

Code	Description
01200	5/16 jic x 5/16 jic
01201	5/16 jic x 7/16 jic
01239	3/8 jic x 3/8 jic
01241	3/8 jic x 7/16 jic
01202	7/16 jic x 7/16 jic
01205	7/16 jic x 1/2 jic
01203	7/16 jic x 9/16 jic
01213	7/16 jic x 3/4 jic
01204	7/16 jic x 7/8 jic
01206	1/2 jic x 1/2 jic
01209	1/2 jic x 9/16 jic
01207	1/2 jic x 3/4 jic
01233	1/2 jic x 7/8 jic
01208	1/2 jic x 1-1/16 jic
01210	9/16 jic x 9/16 jic
01214	9/16 jic x 3/4 jic
01211	9/16 jic x 7/8 jic
01212	9/16 jic x 1-1/16 jic
01237	9/16 jic x 1-3/16 jic
01215	3/4 jic x 3/4 jic
01216	3/4 jic x 7/8 jic
01217	3/4 jic x 1-1/16 jic
01236	3/4 jic x 1-5/16 jic
01243	3/4 jic x 1-5/8 jic
01218	7/8 jic x 7/8 jic
01219	7/8 jic x 1-1/16 jic
01220	7/8 jic x 1-3/16 jic
01221	7/8 jic x 1-5/16 jic

Code	Description
01222	1-1/16 jic x 1-1/16 jic
01223	1-1/16 jic x 1-3/16 jic
01224	1-1/16 jic x 1-5/16 jic
01240	1-1/16 jic x 1-5/8 jic
01238	1-1/16 jic x 1-7/8 jic
01225	1-3/16 jic x 1-3/16 jic
01226	1-3/16 jic x 1-5/16 jic
01227	1-5/16 jic x 1-5/16 jic
01228	1-5/16 jic x 1-5/8 jic
01235	1-5/16 jic x 1-7/8 jic
01246	1-5/16 jic x 2-1/2 jic
01229	1-5/8 jic x 1-5/8 jic
01230	1-5/8 jic x 1-7/8 jic
01231	1-7/8 jic x 1-7/8 jic
01247	1-7/8 jic x 2-1/2 jic
01232	2-1/2 jic x 2-1/2 jic

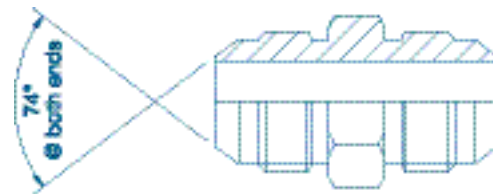

JIC male x JIC male bulkhead LESS LOCKNUT

Code	Description
00192	3/8 jic
00180	7/16 jic
00181	1/2 jic
00182	9/16 jic
00183	3/4 jic
00184	7/8 jic
00185	1-1/16 jic
00186	1-3/16 jic
00187	1-5/16 jic
00188	1-5/8 jic
00189	1-7/8 jic
00193	2-1/2 jic

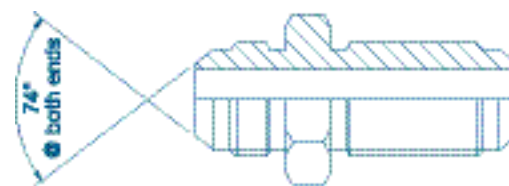

JIC LOCKNUT

Code	Description
00286	3/8 jic
00275	7/16 jic
00276	1/2 jic
00277	9/16 jic
00278	3/4 jic
00279	7/8 jic
00280	1-1/16 jic
00284	1-3/16 jic
00281	1-5/16 jic
00282	1-5/8 jic
00283	1-7/8 jic
00287	2-1/2 jic



JIC male x JIC male bulkhead WITH LOCKNUT

Code	Description
00236	3/8 jic
00225	7/16 jic
00226	1/2 jic
00227	9/16 jic
00228	3/4 jic
00229	7/8 jic
00230	1-1/16 jic
00234	1-3/16 jic
00231	1-5/16 jic
00232	1-5/8 jic
00233	1-7/8 jic
00235	2-1/2 jic

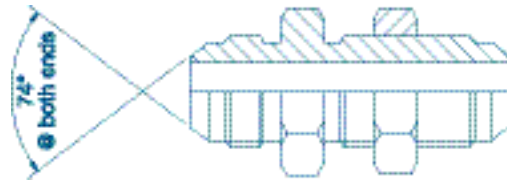

SAE male x SAE male 45° external flare

Code	Description
01234	5/8 sae x 5/8 sae

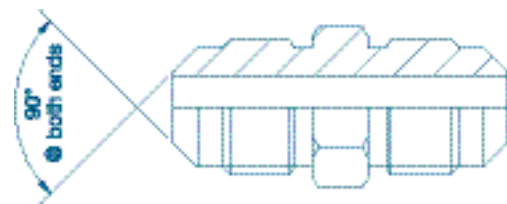

SAE male x SAE male bulkhead 45° external flare

Code	Description
09800	5/8 sae with Locknut
09805	5/8 sae Bulkhead Only
09810	5/8 sae Locknut Only



SAE O’ring boss male LESS O’RING x BSP male

Code	Description
01329	1/4 sorb x 1/8 bsp
01326	1/4 sorb x 1/4 bsp
01300	3/8 sorb x 1/4 bsp
01323	3/8 sorb x 3/8 bsp
01309	7/16 sorb x 1/8 bsp
01301	7/16 sorb x 1/4 bsp
01303	7/16 sorb x 3/8 bsp
01302	7/16 sorb x 1/2 bsp
01304	1/2 sorb x 1/4 bsp
01305	1/2 sorb x 3/8 bsp
01341	1/2 sorb x 1/2 bsp
01306	9/16 sorb x 1/4 bsp
01307	9/16 sorb x 3/8 bsp
01308	9/16 sorb x 1/2 bsp
01315	5/8 sorb x 1/4 bsp
01316	5/8 sorb x 3/8 bsp
01344	5/8 sorb x 1/2 bsp
01310	3/4 sorb x 1/4 bsp
01311	3/4 sorb x 3/8 bsp
01312	3/4 sorb x 1/2 bsp
01313	3/4 sorb x 5/8 bsp
01314	3/4 sorb x 3/4 bsp
01346	7/8 sorb x 1/4 bsp
01317	7/8 sorb x 3/8 bsp
01318	7/8 sorb x 1/2 bsp
01319	7/8 sorb x 5/8 bsp
01320	7/8 sorb x 3/4 bsp
01335	7/8 sorb x 1 bsp

Code	Description
01336	1-1/16 sorb x 1/4 bsp
01321	1-1/16 sorb x 3/8 bsp
01322	1-1/16 sorb x 1/2 bsp
01337	1-1/16 sorb x 5/8 bsp
01324	1-1/16 sorb x 3/4 bsp
01325	1-1/16 sorb x 1 bsp
01348	1-1/16 sorb x 1-1/4 bsp
01345	1-3/16 sorb x 3/4 bsp
01343	1-5/16 sorb x 1/2 bsp
01327	1-5/16 sorb x 3/4 bsp
01328	1-5/16 sorb x 1 bsp
01338	1-5/16 sorb x 1-1/4 bsp
01330	1-5/16 sorb x 1-1/2 bsp
01331	1-5/8 sorb x 3/4 bsp
01332	1-5/8 sorb x 1 bsp
01333	1-5/8 sorb x 1-1/4 bsp
01339	1-5/8 sorb x 1-1/2 bsp
01342	1-7/8 sorb x 1-1/4 bsp
01340	1-7/8 sorb x 1-1/2 bsp

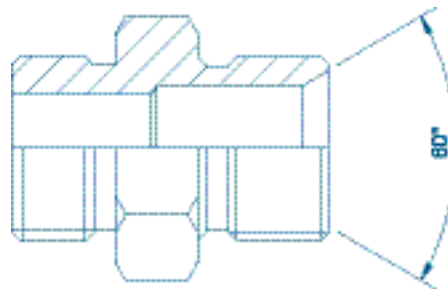

See section 12 for O’rings

SAE O'ring boss male LESS O'RING x JIC male

Code	Description
01350	7/16 sorb x 7/16 jic
01353	7/16 sorb x 1/2 jic
01351	7/16 sorb x 9/16 jic
01398	7/16 sorb x 7/8 jic
01392	1/2 sorb x 7/16 jic
01352	1/2 sorb x 1/2 jic
01388	1/2 sorb x 9/16 jic
01399	9/16 sorb x 3/8 jic
01354	9/16 sorb x 7/16 jic
01355	9/16 sorb x 1/2 jic
01356	9/16 sorb x 9/16 jic
01357	9/16 sorb x 3/4 jic
01358	9/16 sorb x 7/8 jic
01359	5/8 sorb x 7/16 jic
01360	5/8 sorb x 9/16 jic
01375	5/8 sorb x 3/4 jic
01389	3/4 sorb x 7/16 jic
01361	3/4 sorb x 9/16 jic
01362	3/4 sorb x 3/4 jic
01363	3/4 sorb x 7/8 jic
01364	3/4 sorb x 1-1/16 jic
01376	7/8 sorb x 7/16 jic
01382	7/8 sorb x 1/2 jic
01386	7/8 sorb x 9/16 jic
01365	7/8 sorb x 3/4 jic
01366	7/8 sorb x 7/8 jic
01367	7/8 sorb x 1-1/16 jic
01395	1-1/16 sorb x 9/16 jic
01368	1-1/16 sorb x 3/4 jic
01370	1-1/16 sorb x 7/8 jic
01371	1-1/16 sorb x 1-1/16 jic
01372	1-1/16 sorb x 1-3/16 jic
01373	1-1/16 sorb x 1-5/16 jic
01374	1-3/16 sorb x 1-1/16 jic
01391	1-3/16 sorb x 1-3/16 jic
01394	1-5/16 sorb x 3/4 jic
01396	1-5/16 sorb x 7/8 jic
01377	1-5/16 sorb x 1-1/16 jic
01378	1-5/16 sorb x 1-5/16 jic
01379	1-5/16 sorb x 1-5/8 jic
01380	1-5/8 sorb x 1-5/16 jic
01381	1-5/8 sorb x 1-5/8 jic
01387	1-5/8 sorb x 1-7/8 jic
01397	1-7/8 sorb x 1-5/16 jic
01383	1-7/8 sorb x 1-5/8 jic
01384	1-7/8 sorb x 1-7/8 jic
01369	1-7/8 sorb x 2-1/2 jic
01385	2-1/2 sorb x 2-1/2 jic

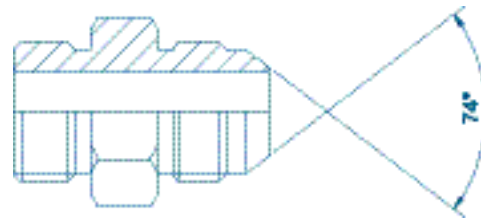

See section 12 for O'rings

SAE O'ring boss male WITH O'RING x BSP male

Code	Description
11309	7/16 sorb x 1/8 bsp
11301	7/16 sorb x 1/4 bsp
11303	7/16 sorb x 3/8 bsp
11302	7/16 sorb x 1/2 bsp
11304	1/2 sorb x 1/4 bsp
11305	1/2 sorb x 3/8 bsp
11341	1/2 sorb x 1/2 bsp
11306	9/16 sorb x 1/4 bsp
11307	9/16 sorb x 3/8 bsp
11308	9/16 sorb x 1/2 bsp
11315	5/8 sorb x 1/4 bsp
11316	5/8 sorb x 3/8 bsp
11344	5/8 sorb x 1/2 bsp
11310	3/4 sorb x 1/4 bsp
11311	3/4 sorb x 3/8 bsp
11312	3/4 sorb x 1/2 bsp
11313	3/4 sorb x 5/8 bsp
11314	3/4 sorb x 3/4 bsp
11317	7/8 sorb x 3/8 bsp
11318	7/8 sorb x 1/2 bsp
11319	7/8 sorb x 5/8 bsp
11320	7/8 sorb x 3/4 bsp
11335	7/8 sorb x 1 bsp
11321	1-1/16 sorb x 3/8 bsp
11322	1-1/16 sorb x 1/2 bsp
11337	1-1/16 sorb x 5/8 bsp
11324	1-1/16 sorb x 3/4 bsp
11325	1-1/16 sorb x 1 bsp
11345	1-3/16 sorb x 3/4 bsp
11343	1-5/16 sorb x 1/2 bsp
11327	1-5/16 sorb x 3/4 bsp
11328	1-5/16 sorb x 1 bsp
11338	1-5/16 sorb x 1-1/4 bsp
11330	1-5/16 sorb x 1-1/2 bsp
11331	1-5/8 sorb x 3/4 bsp
11332	1-5/8 sorb x 1 bsp
11333	1-5/8 sorb x 1-1/4 bsp
11339	1-5/8 sorb x 1-1/2 bsp
11342	1-7/8 sorb x 1-1/4 bsp
11340	1-7/8 sorb x 1-1/2 bsp

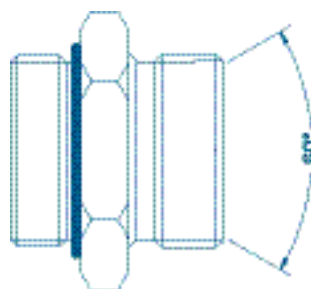

If item with O'Ring is not listed then please contact us for details. Alternatively, see page 26 and change leading 0 to 1.

SAE O'ring boss male WITH O'RING x JIC male

Code	Description
11350	7/16 sorb x 7/16 jic
11353	7/16 sorb x 1/2 jic
11351	7/16 sorb x 9/16 jic
11392	1/2 sorb x 7/16 jic
11352	1/2 sorb x 1/2 jic
11388	1/2 sorb x 9/16 jic
11354	9/16 sorb x 7/16 jic
11355	9/16 sorb x 1/2 jic
11356	9/16 sorb x 9/16 jic
11357	9/16 sorb x 3/4 jic
11358	9/16 sorb x 7/8 jic
11359	5/8 sorb x 7/16 jic
11360	5/8 sorb x 9/16 jic
11375	5/8 sorb x 3/4 jic
11389	3/4 sorb x 7/16 jic
11361	3/4 sorb x 9/16 jic
11362	3/4 sorb x 3/4 jic
11363	3/4 sorb x 7/8 jic
11364	3/4 sorb x 1-1/16 jic
11376	7/8 sorb x 7/16 jic
11382	7/8 sorb x 1/2 jic
11386	7/8 sorb x 9/16 jic
11365	7/8 sorb x 3/4 jic
11366	7/8 sorb x 7/8 jic
11367	7/8 sorb x 1-1/16 jic
11395	1-1/16 sorb x 9/16 jic
11368	1-1/16 sorb x 3/4 jic
11370	1-1/16 sorb x 7/8 jic
11371	1-1/16 sorb x 1-1/16 jic
11372	1-1/16 sorb x 1-3/16 jic
11373	1-1/16 sorb x 1-5/16 jic
11374	1-3/16 sorb x 1-1/16 jic
11391	1-3/16 sorb x 1-3/16 jic
11394	1-5/16 sorb x 3/4 jic
11396	1-5/16 sorb x 7/8 jic
11377	1-5/16 sorb x 1-1/16 jic
11378	1-5/16 sorb x 1-5/16 jic
11379	1-5/16 sorb x 1-5/8 jic
11380	1-5/8 sorb x 1-5/16 jic
11381	1-5/8 sorb x 1-5/8 jic
11387	1-5/8 sorb x 1-7/8 jic
11397	1-7/8 sorb x 1-5/16 jic
11383	1-7/8 sorb x 1-5/8 jic
11384	1-7/8 sorb x 1-7/8 jic
11369	1-7/8 sorb x 2-1/2 jic
11385	2-1/2 sorb x 2-1/2 jic

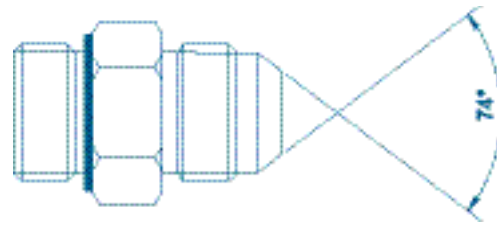

If item with O'Ring is not listed then please contact us for details. Alternatively, see page 27 and change leading 0 to 1.

BSP male x BSP male with restrictor

Code	Description
13079-R2.0	1/8 bsp x 1/8 bsp x 2mm
13080-R0.6	1/4 bsp x 1/4 bsp x 0.6mm
13091	1/4 bsp x 1/4 bsp x 1/32
13092	1/4 bsp x 1/4 bsp x 1mm
13080-R1.4	1/4 bsp x 1/4 bsp x 1.4mm
13093	1/4 bsp x 1/4 bsp x 1/16
13080-R2.0	1/4 bsp x 1/4 bsp x 2mm
13080-R2.5	1/4 bsp x 1/4 bsp x 2.5mm
13094	1/4 bsp x 3/8 bsp x 1/32
13095	1/4 bsp x 3/8 bsp x 1mm
13081-R1.4	1/4 bsp x 3/8 bsp x 1.4mm
13096	1/4 bsp x 3/8 bsp x 1/16
13081-R2.0	1/4 bsp x 3/8 bsp x 2mm
13081-R3.0	1/4 bsp x 3/8 bsp x 3mm
13097	1/4 bsp x 1/2 bsp x 1/32
13098	1/4 bsp x 1/2 bsp x 1mm
13099	1/4 bsp x 1/2 bsp x 1/16
13082-R2.0	1/4 bsp x 1/2 bsp x 2mm
13082-R3.0	1/4 bsp x 1/2 bsp x 3mm
13100	3/8 bsp x 3/8 bsp x 1/32
13101	3/8 bsp x 3/8 bsp x 1mm
13102	3/8 bsp x 3/8 bsp x 1/16
13083-R2.0	3/8 bsp x 3/8 bsp x 2mm
13083-R3.0	3/8 bsp x 3/8 bsp x 3mm
13083-R4.0	3/8 bsp x 3/8 bsp x 4mm
13103	3/8 bsp x 1/2 bsp x 1/32
13104	3/8 bsp x 1/2 bsp x 1mm
13105	3/8 bsp x 1/2 bsp x 1/16
13084-R2.0	3/8 bsp x 1/2 bsp x 2mm
13084-R2.4	3/8 bsp x 1/2 bsp x 2.4mm
13084-R2.5	3/8 bsp x 1/2 bsp x 2.5mm
13109	3/8 bsp x 1/2 bsp x 3mm
13089-R1/32	3/8 bsp x 3/4 bsp x 1/32
13110	3/8 bsp x 3/4 bsp x 1/16
13089-R2.0	3/8 bsp x 3/4 bsp x 2mm
13089-R3.0	3/8 bsp x 3/4 bsp x 3mm
13106	1/2 bsp x 1/2 bsp x 1/32
13107	1/2 bsp x 1/2 bsp x 1mm
13085-R1.4	1/2 bsp x 1/2 bsp x 1.4mm
13108	1/2 bsp x 1/2 bsp x 1/16
13085-R2.0	1/2 bsp x 1/2 bsp x 2mm
13085-R3.0	1/2 bsp x 1/2 bsp x 3mm
13086-R1.0	1/2 bsp x 3/4 bsp x 1mm
13087-R1.0	3/4 bsp x 3/4 bsp x 1mm
13087-R2.5	3/4 bsp x 3/4 bsp x 2.5mm

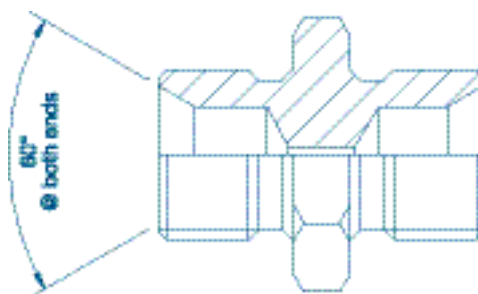

Other sizes in this range may be available on request.

BSP male x BSP male restrictor blank only

Code	Description
13119	1/8 bsp x 1/4 bsp
13080	1/4 bsp x 1/4 bsp
13081	1/4 bsp x 3/8 bsp
13082	1/4 bsp x 1/2 bsp
13083	3/8 bsp x 3/8 bsp
13084	3/8 bsp x 1/2 bsp
13089	3/8 bsp x 3/4 bsp
13085	1/2 bsp x 1/2 bsp
13086	1/2 bsp x 3/4 bsp
13087	3/4 bsp x 3/4 bsp
13088	3/4 bsp x 1 bsp
13090	1 bsp x 1 bsp
13117	1-1/4 bsp x 1-1/4 bsp

Other sizes in this range may be available on request.

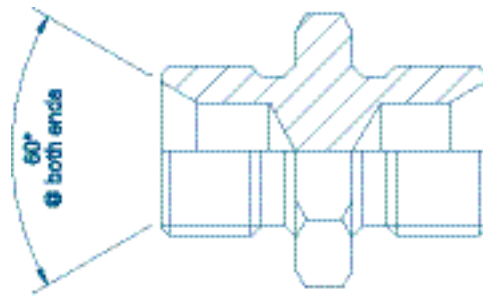

BSP male x JIC male restrictor blank only

Code	Description
13229	1/8 bsp x 7/16 jic
13234	1/4 bsp x 7/16 jic
13230	1/4 bsp x 9/16 jic
13231	3/8 bsp x 7/16 jic
13232	3/8 bsp x 9/16 jic
13233	1/2 bsp x 9/16 jic
13235	3/4 bsp x 1-1/16 jic

Other sizes in this range may be available on request.

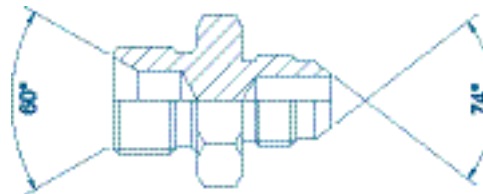

METRIC male 1.5mm pitch x JIC male restrictor blank only

Code	Description
13401	14 mm x 9/16 jic
13400	18 mm x 9/16 jic

Other sizes in this range may be available on request.

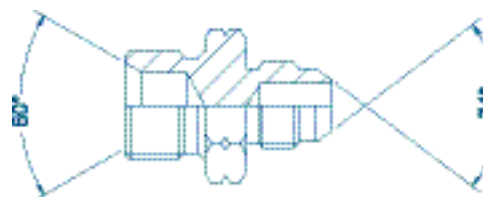

JIC male x JIC male restrictor blank only

Code	Description
13500	7/16 jic x 7/16 jic

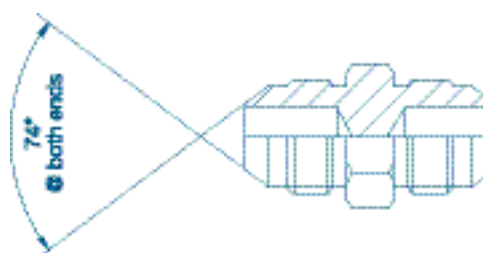

Contents Section 2

33	BSP male x BSP swivel female
34	BSP male x BSP flat faced swivel female
34	BSP male DIN 3852 Form A x BSP swivel female
35	BSP male x METRIC swivel female 1.5mm pitch
35	BSP male x JIC swivel female
36	BSP male x BSP swivel female BODIES ONLY
36	BSP male x NPSM swivel female
<hr/>	
37	BSPT male x BSP swivel female
37	BSPT male x JIC swivel female
<hr/>	
37	NPTF male x BSP swivel female
38	NPTF male x NPSM swivel female
38	NPTF male x JIC swivel female
<hr/>	
38	METRIC male x METRIC swivel female 1.5mm pitch
39	METRIC male 1.5mm pitch x BSP swivel female
39	METRIC male 1.5mm pitch x JIC swivel female
<hr/>	
40	JIC male x JIC swivel female
40	JIC male x BSP swivel female
41	JIC male x METRIC swivel female 1.5mm pitch
<hr/>	
41	SAE O'ring boss male LESS O'RING x JIC swivel female
<hr/>	
42	BSP male x BSP swivel female TEST POINT ADAPTORS
42	TEST POINT Fitting with male thread

BSP male x BSP swivel female

Code	Description
01425	1/8 bsp x 1/8 bsp
01426	1/8 bsp x 1/4 bsp
01476	1/8 bsp x 3/8 bsp
01428	1/4 bsp x 1/8 bsp
01427	1/4 bsp x 1/4 bsp
01429	1/4 bsp x 3/8 bsp
01430	1/4 bsp x 1/2 bsp
01431	1/4 bsp x 3/4 bsp
01432	3/8 bsp x 1/8 bsp
01433	3/8 bsp x 1/4 bsp
01434	3/8 bsp x 3/8 bsp
01435	3/8 bsp x 1/2 bsp
01470	3/8 bsp x 5/8 bsp
01436	3/8 bsp x 3/4 bsp
01437	3/8 bsp x 1 bsp
01438	1/2 bsp x 1/4 bsp
01439	1/2 bsp x 3/8 bsp
01440	1/2 bsp x 1/2 bsp
01441	1/2 bsp x 5/8 bsp
01442	1/2 bsp x 3/4 bsp
01443	1/2 bsp x 1 bsp
01457	5/8 bsp x 1/4 bsp
01444	5/8 bsp x 3/8 bsp
01445	5/8 bsp x 1/2 bsp
01446	5/8 bsp x 5/8 bsp
01447	5/8 bsp x 3/4 bsp
01481	5/8 bsp x 1 bsp
01487	5/8 bsp x 1-1/2 bsp
01468	3/4 bsp x 1/4 bsp
01448	3/4 bsp x 3/8 bsp
01449	3/4 bsp x 1/2 bsp
01450	3/4 bsp x 5/8 bsp
01451	3/4 bsp x 3/4 bsp
01453	3/4 bsp x 1 bsp
01452	3/4 bsp x 1-1/4 bsp
01482	3/4 bsp x 1-1/2 bsp
01484	1 bsp x 3/8 bsp
01454	1 bsp x 1/2 bsp
01455	1 bsp x 5/8 bsp
01456	1 bsp x 3/4 bsp
01458	1 bsp x 1 bsp
01463	1 bsp x 1-1/4 bsp
01472	1 bsp x 1-1/2 bsp
01479	1 bsp x 2 bsp
01459	1-1/4 bsp x 1/2 bsp
01469	1-1/4 bsp x 3/4 bsp
01460	1-1/4 bsp x 1 bsp
01461	1-1/4 bsp x 1-1/4 bsp
01462	1-1/4 bsp x 1-1/2 bsp
01477	1-1/4 bsp x 2 bsp

Code	Description
01464	1-1/2 bsp x 1 bsp
01465	1-1/2 bsp x 1-1/4 bsp
01466	1-1/2 bsp x 1-1/2 bsp
01471	1-1/2 bsp x 2 bsp
01475	2 bsp x 1-1/4 bsp
01474	2 bsp x 1-1/2 bsp
01467	2 bsp x 2 bsp

Note: If soft seal is required on the female, these are available on request.

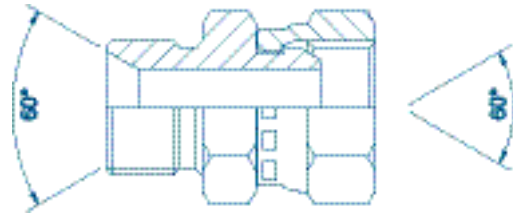

BSP male x BSP flat faced swivel female

Code	Description
11426	1/8 bsp x 1/4 bsp
11427	1/4 bsp x 1/4 bsp
11429	1/4 bsp x 3/8 bsp
11433	3/8 bsp x 1/4 bsp
11434	3/8 bsp x 3/8 bsp
11435	3/8 bsp x 1/2 bsp
11436	3/8 bsp x 3/4 bsp
11440	1/2 bsp x 1/2 bsp
11442	1/2 bsp x 3/4 bsp
11446	5/8 bsp x 5/8 bsp
11451	3/4 bsp x 3/4 bsp
11458	1 bsp x 1 bsp
11463	1 bsp x 1-1/4 bsp
11467	2 bsp x 2 bsp

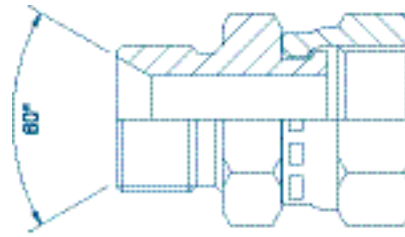

Other sizes in this range may be available on request.

BSP male DIN 3852 FORM A x BSP swivel female

Code	Description
61400	1/8 bsp x 1/8 bsp
61401	1/8 bsp x 1/4 bsp
61402	1/8 bsp x 3/8 bsp
61403	1/4 bsp x 1/8 bsp
61404	1/4 bsp x 1/4 bsp
61405	1/4 bsp x 3/8 bsp
61406	1/4 bsp x 1/2 bsp
61407	1/4 bsp x 3/4 bsp
61408	3/8 bsp x 1/8 bsp
61409	3/8 bsp x 1/4 bsp
61410	3/8 bsp x 3/8 bsp
61411	3/8 bsp x 1/2 bsp
61413	3/8 bsp x 3/4 bsp
61414	3/8 bsp x 1 bsp
61415	1/2 bsp x 1/4 bsp
61416	1/2 bsp x 3/8 bsp
61417	1/2 bsp x 1/2 bsp
61419	1/2 bsp x 3/4 bsp
61420	1/2 bsp x 1 bsp
61427	3/4 bsp x 1/4 bsp
61428	3/4 bsp x 3/8 bsp
61429	3/4 bsp x 1/2 bsp
61431	3/4 bsp x 3/4 bsp
61432	3/4 bsp x 1 bsp
61433	3/4 bsp x 1-1/4 bsp

Code	Description
61434	1 bsp x 1/2 bsp
61436	1 bsp x 3/4 bsp
61437	1 bsp x 1 bsp
61438	1 bsp x 1-1/4 bsp
61439	1 bsp x 1-1/2 bsp
61453	1 bsp x 2 bsp
61440	1-1/4 bsp x 1/2 bsp
61441	1-1/4 bsp x 3/4 bsp
61442	1-1/4 bsp x 1 bsp
61443	1-1/4 bsp x 1-1/4 bsp
61444	1-1/4 bsp x 1-1/2 bsp
61445	1-1/4 bsp x 2 bsp
61446	1-1/2 bsp x 1 bsp
61447	1-1/2 bsp x 1-1/4 bsp
61448	1-1/2 bsp x 1-1/2 bsp
61449	1-1/2 bsp x 2 bsp
61450	2 bsp x 1-1/4 bsp
61451	2 bsp x 1-1/2 bsp
61452	2 bsp x 2 bsp

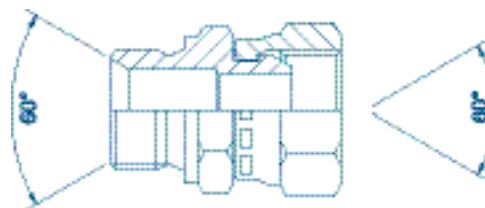

BSP male x METRIC swivel female 1.5mm pitch

Code	Description
01500	1/4 bsp x 12mm
01501	1/4 bsp x 14mm
01502	1/4 bsp x 16mm
01514	1/4 bsp x 18mm
01516	3/8 bsp x 12mm
01504	3/8 bsp x 14mm
01503	3/8 bsp x 16mm
01505	3/8 bsp x 18mm
01506	3/8 bsp x 20mm
01507	3/8 bsp x 22mm
01515	1/2 bsp x 14mm
01508	1/2 bsp x 16mm
01509	1/2 bsp x 18mm
01510	1/2 bsp x 20mm
01511	1/2 bsp x 22mm
01517	1/2 bsp x 24mm
01519	1/2 bsp x 26mm

Code	Description
01513	5/8 bsp x 22mm
01498	3/4 bsp x 18mm
01499	3/4 bsp x 20mm
01512	3/4 bsp x 22mm

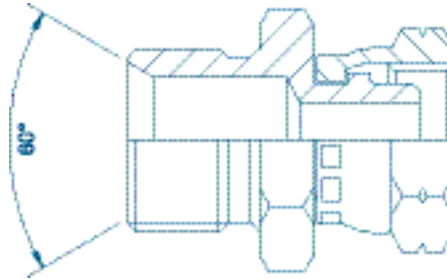

BSP male x JIC swivel female

Code	Description
11501	1/8 bsp x 7/16 jic
11513	1/4 bsp x 7/16 jic
11514	1/4 bsp x 1/2 jic
11515	1/4 bsp x 9/16 jic
11516	1/4 bsp x 3/4 jic
11524	3/8 bsp x 7/16 jic
11525	3/8 bsp x 1/2 jic
11526	3/8 bsp x 9/16 jic
11527	3/8 bsp x 3/4 jic
11528	3/8 bsp x 7/8 jic
11529	3/8 bsp x 1-1/16 jic
11531	3/8 bsp x 1-5/16 jic
11536	1/2 bsp x 7/16 jic
11537	1/2 bsp x 1/2 jic
11538	1/2 bsp x 9/16 jic
11539	1/2 bsp x 3/4 jic
11540	1/2 bsp x 7/8 jic
11541	1/2 bsp x 1-1/16 jic
11551	5/8 bsp x 3/4 jic
11552	5/8 bsp x 7/8 jic
11553	5/8 bsp x 1-1/16 jic
11562	3/4 bsp x 9/16 jic
11563	3/4 bsp x 3/4 jic
11564	3/4 bsp x 7/8 jic
11565	3/4 bsp x 1-1/16 jic
11566	3/4 bsp x 1-3/16 jic
11567	3/4 bsp x 1-5/16 jic
11568	3/4 bsp x 1-5/8 jic

Code	Description
11577	1 bsp x 1-1/16 jic
11578	1 bsp x 1-3/16 jic
11579	1 bsp x 1-5/16 jic
11580	1 bsp x 1-5/8 jic
11591	1-1/4 bsp x 1-5/16 jic
11592	1-1/4 bsp x 1-5/8 jic
11593	1-1/4 bsp x 1-7/8 jic
11606	1-1/2 bsp x 1-5/8 jic
11605	1-1/2 bsp x 1-7/8 jic
11619	1-1/2 bsp x 2-1/2 jic
11617	2 bsp x 1-7/8 jic
11618	2 bsp x 2-1/2 jic

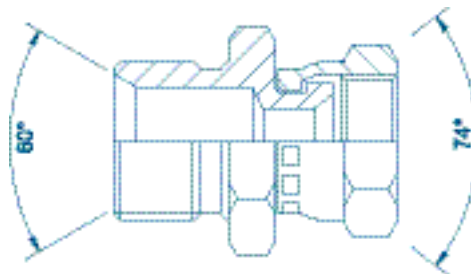

BSP male x BSP swivel female BODIES ONLY

Also suitable for NPSM Crimp Nuts

Code	Description
21425	1/8 bsp x 1/8 bsp
21426	1/8 bsp x 1/4 bsp
21428	1/4 bsp x 1/8 bsp
21427	1/4 bsp x 1/4 bsp
21429	1/4 bsp x 3/8 bsp
21430	1/4 bsp x 1/2 bsp
21431	1/4 bsp x 3/4 bsp
21433	3/8 bsp x 1/4 bsp
21434	3/8 bsp x 3/8 bsp
21435	3/8 bsp x 1/2 bsp
21470	3/8 bsp x 5/8 bsp
21436	3/8 bsp x 3/4 bsp
21437	3/8 bsp x 1 bsp
21438	1/2 bsp x 1/4 bsp
21439	1/2 bsp x 3/8 bsp
21440	1/2 bsp x 1/2 bsp
21441	1/2 bsp x 5/8 bsp
21442	1/2 bsp x 3/4 bsp
21443	1/2 bsp x 1 bsp
21444	5/8 bsp x 3/8 bsp
21445	5/8 bsp x 1/2 bsp
21446	5/8 bsp x 5/8 bsp
21447	5/8 bsp x 3/4 bsp
21448	3/4 bsp x 3/8 bsp
21449	3/4 bsp x 1/2 bsp
21450	3/4 bsp x 5/8 bsp
21451	3/4 bsp x 3/4 bsp
21453	3/4 bsp x 1 bsp
21452	3/4 bsp x 1-1/4 bsp

Code	Description
21454	1 bsp x 1/2 bsp
21455	1 bsp x 5/8 bsp
21456	1 bsp x 3/4 bsp
21458	1 bsp x 1 bsp
21463	1 bsp x 1-1/4 bsp
21459	1-1/4 bsp x 1/2 bsp
21469	1-1/4 bsp x 3/4 bsp
21460	1-1/4 bsp x 1 bsp
21461	1-1/4 bsp x 1-1/4 bsp
21462	1-1/4 bsp x 1-1/2 bsp
21464	1-1/2 bsp x 1 bsp
21465	1-1/2 bsp x 1-1/4 bsp
21466	1-1/2 bsp x 1-1/2 bsp
21471	1-1/2 bsp x 2 bsp
21467	2 bsp x 2 bsp

Due to ever increasing demand for Crimped items, there may be long delays for these bodies.

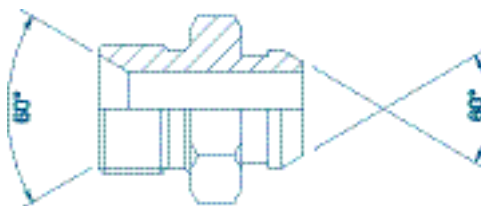

BSP male x NPSM swivel female

Code	Description
31427	1/4 bsp x 1/4 npsm
31429	1/4 bsp x 3/8 npsm
31433	3/8 bsp x 1/4 npsm
31434	3/8 bsp x 3/8 npsm
31435	3/8 bsp x 1/2 npsm
31438	1/2 bsp x 1/4 npsm
31439	1/2 bsp x 3/8 npsm
31440	1/2 bsp x 1/2 npsm



BSPT male x BSP swivel female

Code	Description
01875	1/8 bspt x 1/8 bsp
01876	1/4 bspt x 1/4 bsp
01877	3/8 bspt x 3/8 bsp
01885	3/8 bspt x 1/2 bsp
01884	1/2 bspt x 3/8 bsp
01878	1/2 bspt x 1/2 bsp
01879	5/8 bspt x 5/8 bsp
01880	3/4 bspt x 1/2 bsp
01881	3/4 bspt x 3/4 bsp
01887	3/4 bspt x 1 bsp
01882	1 bspt x 3/4 bsp
01883	1 bspt x 1 bsp
01889	1-1/4 bspt x 1-1/4 bsp
01888	1-1/2 bspt x 1-1/2 bsp
01891	2 bspt x 1-1/2 bsp
01886	2 bspt x 2 bsp

Note: Coned Bspt is available on request.

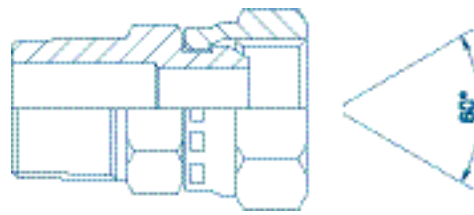

BSPT male x JIC swivel female

Code	Description	Price
10200	1/4 bspt x 7/16 jic	£ 0.92

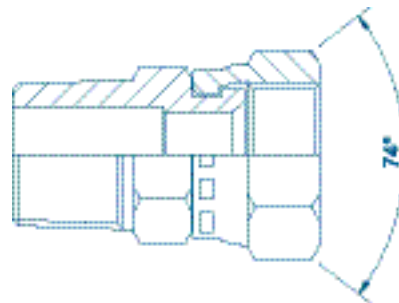

NPTF male x BSP swivel female

Code	Description
11875	1/8 nptf x 1/8 bsp
11876	1/4 nptf x 1/4 bsp
11873	1/4 nptf x 3/8 bsp
11885	3/8 nptf x 1/4 bsp
11877	3/8 nptf x 3/8 bsp
11884	3/8 nptf x 1/2 bsp
11874	1/2 nptf x 3/8 bsp
11878	1/2 nptf x 1/2 bsp
11879	1/2 nptf x 3/4 bsp
11880	3/4 nptf x 1/2 bsp
11881	3/4 nptf x 3/4 bsp
11882	1 nptf x 3/4 bsp
11883	1 nptf x 1 bsp
11888	1-1/2 nptf x 1-1/2 bsp
11886	2 nptf x 2 bsp

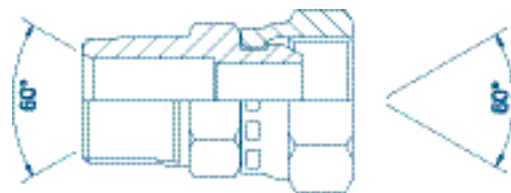

NPTF male x NPSM swivel female

Code	Description
10875	1/8 nptf x 1/8 npsm
10876	1/4 nptf x 1/4 npsm
10886	1/4 nptf x 3/8 npsm
10872	3/8 nptf x 1/4 npsm
10877	3/8 nptf x 3/8 npsm
10884	3/8 nptf x 1/2 npsm
10874	1/2 nptf x 3/8 npsm
10878	1/2 nptf x 1/2 npsm
10879	1/2 nptf x 3/4 npsm
10880	3/4 nptf x 1/2 npsm
10881	3/4 nptf x 3/4 npsm
10887	3/4 nptf x 1 npsm
10882	1 nptf x 3/4 npsm
10885	1 nptf x 1 npsm
10883	1-1/2 nptf x 1-1/2 npsm

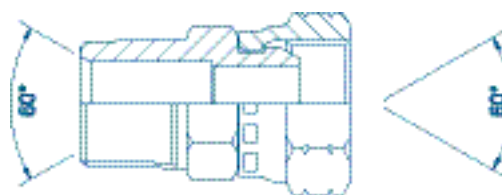

NPTF male x JIC swivel female

Code	Description
11200	1/8 nptf x 7/16 jic
11206	1/4 nptf x 1/2 jic
11201	1/4 nptf x 9/16 jic
11202	3/8 nptf x 3/4 jic
11203	1/2 nptf x 7/8 jic
11204	3/4 nptf x 1-1/16 jic
11205	1 nptf x 1-5/16 jic

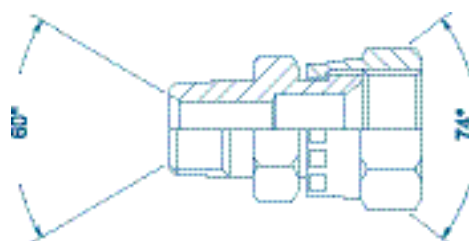

METRIC male x METRIC swivel female 1.5mm pitch

Code	Description
01700	12mm x 12mm
01701	14mm x 14mm
01702	16mm x 16mm
01709	16mm x 18mm
01710	18mm x 16mm
01703	18mm x 18mm
01704	18mm x 20mm
01711	18mm x 22mm
01712	20mm x 18mm
01705	20mm x 20mm
01713	20mm x 22mm
01707	22mm x 18mm
01708	22mm x 20mm
01706	22mm x 22mm

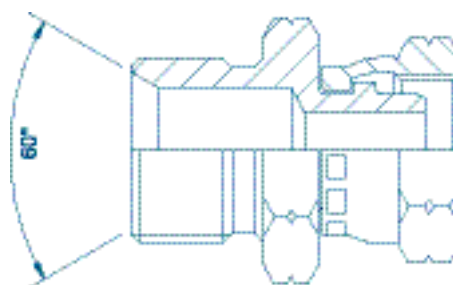

METRIC male 1.5mm pitch x BSP swivel female

Code	Description
01550	12mm x 1/4 bsp
01572	12mm x 3/8 bsp
01551	14mm x 1/4 bsp
01554	14mm x 3/8 bsp
01552	14mm x 1/2 bsp
01553	16mm x 1/4 bsp
01555	16mm x 3/8 bsp
01559	16mm x 1/2 bsp
01570	16mm x 3/4 bsp
01556	18mm x 3/8 bsp
01560	18mm x 1/2 bsp
01557	20mm x 3/8 bsp
01561	20mm x 1/2 bsp
01567	20mm x 3/4 bsp
01558	22mm x 3/8 bsp
01562	22mm x 1/2 bsp
01563	22mm x 3/4 bsp
01573	24mm x 1/2 bsp
01564	26mm x 3/8 bsp
01565	26mm x 1/2 bsp
01566	26mm x 3/4 bsp
01568	30mm x 3/8 bsp
01569	30mm x 1/2 bsp

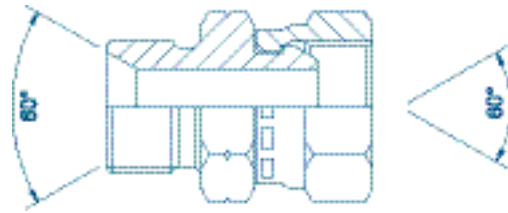

METRIC male 1.5mm pitch x JIC swivel female

Code	Description
01639	12mm x 7/16 jic
01625	12mm x 1/2 jic
01626	14mm x 9/16 jic
01627	16mm x 9/16 jic
01628	16mm x 3/4 jic
01629	16mm x 7/8 jic
01630	18mm x 9/16 jic
01631	18mm x 3/4 jic
01632	18mm x 7/8 jic
01633	20mm x 9/16 jic
01634	20mm x 3/4 jic
01638	20mm x 7/8 jic
01635	22mm x 9/16 jic
01636	22mm x 3/4 jic
01637	22mm x 7/8 jic

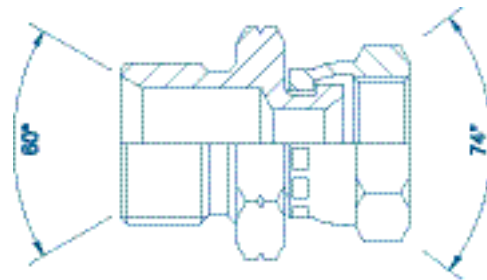

JIC male x JIC swivel female

Code	Description
01687	7/16 jic x 7/16 jic
01675	7/16 jic x 9/16 jic
01694	7/16 jic x 3/4 jic
01671	7/16 jic x 7/8 jic
01670	1/2 jic x 7/16 jic
01676	1/2 jic x 1/2 jic
01677	1/2 jic x 9/16 jic
01684	9/16 jic x 7/16 jic
01674	9/16 jic x 1/2 jic
01678	9/16 jic x 9/16 jic
01679	9/16 jic x 3/4 jic
01695	9/16 jic x 7/8 jic
01774	9/16 jic x 1-1/16 jic
01680	3/4 jic x 9/16 jic
01685	3/4 jic x 3/4 jic
01681	3/4 jic x 7/8 jic
01691	3/4 jic x 1-1/16 jic
01773	3/4 jic x 1-5/8 jic
01682	7/8 jic x 3/4 jic
01683	7/8 jic x 7/8 jic
01690	7/8 jic x 1-1/16 jic
01688	1-1/16 jic x 3/4 jic
01686	1-1/16 jic x 7/8 jic
01692	1-1/16 jic x 1-1/16 jic
01696	1-1/16 jic x 1-5/16 jic
01666	1-1/16 jic x 1-5/8 jic

Code	Description
01699	1-3/16 jic x 1-3/16 jic
01689	1-5/16 jic x 1-1/16 jic
01693	1-5/16 jic x 1-5/16 jic
01673	1-5/16 jic x 1-5/8 jic
01669	1-5/16 jic x 1-7/8 jic
01770	1-5/8 jic x 1-5/16 jic
01697	1-5/8 jic x 1-5/8 jic
01672	1-5/8 jic x 1-7/8 jic
01698	1-7/8 jic x 1-7/8 jic
01667	1-7/8 jic x 2-1/2 jic

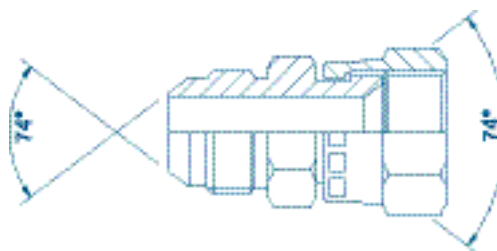

JIC male x BSP swivel female

Code	Description
01600	7/16 jic x 1/8 bsp
01605	7/16 jic x 1/4 bsp
01614	7/16 jic x 3/8 bsp
01613	7/16 jic x 1/2 bsp
01601	1/2 jic x 1/4 bsp
01618	1/2 jic x 3/8 bsp
01617	1/2 jic x 1/2 bsp
01602	9/16 jic x 1/4 bsp
01603	9/16 jic x 3/8 bsp
01604	9/16 jic x 1/2 bsp
01606	3/4 jic x 3/8 bsp
01607	3/4 jic x 1/2 bsp
01599	3/4 jic x 5/8 bsp
01620	3/4 jic x 3/4 bsp
01608	7/8 jic x 3/8 bsp
01609	7/8 jic x 1/2 bsp
01619	7/8 jic x 5/8 bsp
01615	7/8 jic x 3/4 bsp

Code	Description
01594	1-1/16 jic x 1/2 bsp
01610	1-1/16 jic x 3/4 bsp
01616	1-1/16 jic x 1 bsp
01623	1-3/16 jic x 3/4 bsp
01624	1-5/16 jic x 3/4 bsp
01611	1-5/16 jic x 1 bsp
01612	1-5/8 jic x 1-1/4 bsp
01597	1-5/8 jic x 1-1/2 bsp
01598	1-7/8 jic x 1-1/2 bsp

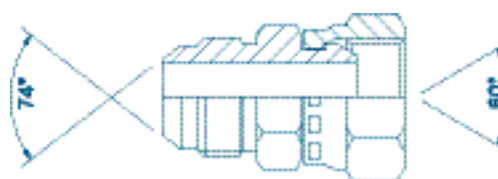

JIC male x METRIC swivel female 1.5mm pitch

Code	Description
01664	7/16 jic x 12mm
01665	7/16 jic x 14mm
01650	1/2 jic x 12mm
01651	9/16 jic x 14mm
01652	9/16 jic x 16mm
01653	9/16 jic x 18mm
01654	9/16 jic x 20mm
01655	9/16 jic x 22mm
01656	3/4 jic x 16mm
01657	3/4 jic x 18mm
01658	3/4 jic x 20mm
01659	3/4 jic x 22mm
01660	7/8 jic x 16mm
01661	7/8 jic x 18mm
01662	7/8 jic x 20mm
01663	7/8 jic x 22mm

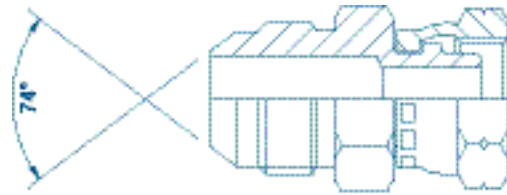

SAE O'ring boss male x JIC swivel female

Code	Description
11685	3/4 sorb x 3/4 jic

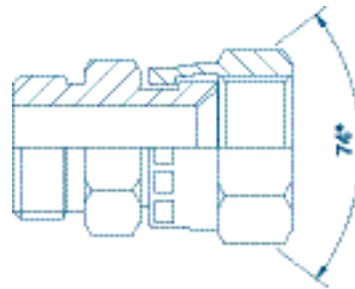

BSP male x BSP swivel female TEST POINT adaptors

Code	Description
01425-TP-B02	1/8 bsp x 1/8 bsp + 1/8 Test Point
01427-TP-B02	1/4 bsp x 1/4 bsp + 1/8 Test Point
01434-TP-B02	3/8 bsp x 3/8 bsp + 1/8 Test Point
01440-TP-B02	1/2 bsp x 1/2 bsp + 1/8 Test Point
01451-TP-B02	3/4 bsp x 3/4 bsp + 1/8 Test Point
01458-TP-B02	1 bsp x 1 bsp + 1/8 Test Point
01461-TP-B02	1-1/4 bsp x 1-1/4 bsp + 1/8 Test Point
01427-TP-B04	1/4 bsp x 1/4 bsp + 1/4 Test Point
01440-TP-B04	1/2 bsp x 1/2 bsp + 1/4 Test Point
01458-TP-B04	1 bsp x 1 bsp + 1/4 Test Point

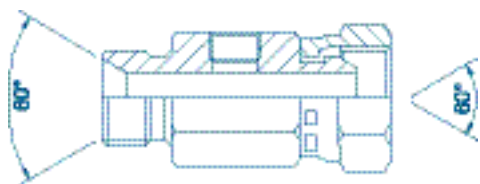

Fitting not included. Other styles and sizes are available on request.

TEST POINT Fitting with male thread

Code	Description
MTP/B02-M16/2S	1/8 bsp male T/P + 16mm by 2mm Steel Cap
MTP/B04-M16/2S	1/4 bsp male T/P + 16mm by 2mm Steel Cap

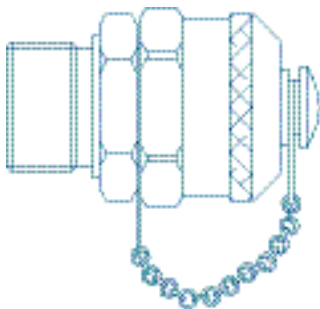

Contents Section 3

44	BSP swivel female x BSP swivel female
44	BSP swivel female x METRIC swivel female 1.5mm pitch
45	BSP swivel female x JIC swivel female
45	METRIC swivel female x METRIC swivel female 1.5mm pitch
<hr/>	
46	JIC swivel female x JIC swivel female
46	NPTF fixed female x BSP swivel female
<hr/>	
46	BSP swivel female x BSP swivel female BODIES ONLY
<hr/>	

BSP swivel female x BSP swivel female

Code	Description
01725	1/8 bsp x 1/8 bsp
01726	1/8 bsp x 1/4 bsp
01751	1/8 bsp x 3/8 bsp
01727	1/4 bsp x 1/4 bsp
01728	1/4 bsp x 3/8 bsp
01732	1/4 bsp x 1/2 bsp
01736	1/4 bsp x 5/8 bsp
01724	1/4 bsp x 3/4 bsp
01729	3/8 bsp x 3/8 bsp
01733	3/8 bsp x 1/2 bsp
01737	3/8 bsp x 5/8 bsp
01730	3/8 bsp x 3/4 bsp
01731	3/8 bsp x 1 bsp
01734	1/2 bsp x 1/2 bsp
01746	1/2 bsp x 5/8 bsp
01735	1/2 bsp x 3/4 bsp
01750	1/2 bsp x 1 bsp
01738	5/8 bsp x 5/8 bsp
01740	5/8 bsp x 3/4 bsp
01739	5/8 bsp x 1 bsp

Code	Description
01741	3/4 bsp x 3/4 bsp
01742	3/4 bsp x 1 bsp
01747	3/4 bsp x 1-1/4 bsp
01743	1 bsp x 1 bsp
01744	1 bsp x 1-1/4 bsp
01752	1 bsp x 1-1/2 bsp
01745	1-1/4 bsp x 1-1/4 bsp
01753	1-1/4 bsp x 1-1/2 bsp
01756	1-1/4 bsp x 2 bsp
01748	1-1/2 bsp x 1-1/2 bsp
01755	1-1/2 bsp x 2 bsp
01749	2 bsp x 2 bsp

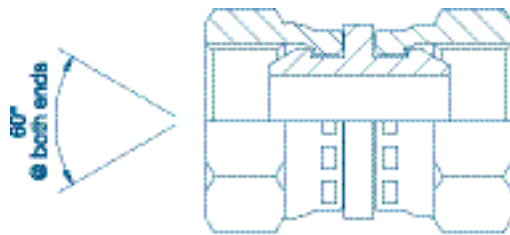

BSP swivel female x METRIC swivel female 1.5mm pitch

Code	Description
01800	1/4 bsp x 12mm
01801	1/4 bsp x 14mm
01802	3/8 bsp x 12mm
01804	3/8 bsp x 14mm
01805	3/8 bsp x 16mm
01806	3/8 bsp x 18mm
01807	3/8 bsp x 20mm
01808	3/8 bsp x 22mm
01809	1/2 bsp x 16mm
01810	1/2 bsp x 18mm
01811	1/2 bsp x 20mm
01812	1/2 bsp x 22mm
01813	5/8 bsp x 18mm

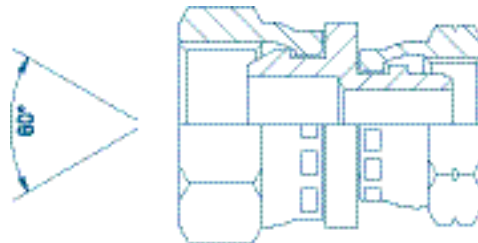

BSP swivel female x JIC swivel female

Code	Description
01859	1/4 bsp x 7/16 jic
01861	1/4 bsp x 1/2 jic
01850	1/4 bsp x 9/16 jic
01872	1/4 bsp x 1-1/16 jic
01860	3/8 bsp x 7/16 jic
01868	3/8 bsp x 1/2 jic
01851	3/8 bsp x 9/16 jic
01852	3/8 bsp x 3/4 jic
01853	3/8 bsp x 7/8 jic
01854	1/2 bsp x 9/16 jic
01855	1/2 bsp x 3/4 jic
01856	1/2 bsp x 7/8 jic
01862	1/2 bsp x 1-1/16 jic
01858	5/8 bsp x 7/8 jic
01857	3/4 bsp x 3/4 jic
01863	3/4 bsp x 1-1/16 jic
01869	3/4 bsp x 1-3/16 jic
01865	3/4 bsp x 1-5/16 jic

Code	Description
01866	1 bsp x 1-1/16 jic
01864	1 bsp x 1-5/16 jic
01870	1-1/4 bsp x 1-5/16 jic
01867	1-1/4 bsp x 1-5/8 jic
01871	1-1/2 bsp x 1-7/8 jic

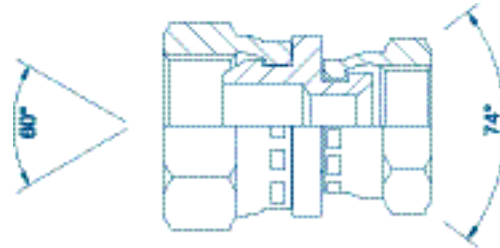

METRIC swivel female x METRIC swivel female 1.5mm pitch

Code	Description
01775	12mm x 12mm
01785	12mm x 14mm
01776	14mm x 14mm
01777	16mm x 16mm
01782	16mm x 18mm
01778	18mm x 18mm
01783	18mm x 20mm
01779	18mm x 22mm
01780	20mm x 20mm
01784	20mm x 22mm
01781	22mm x 22mm



JIC swivel female x JIC swivel female

Code	Description
01825	7/16 jic x 7/16 jic
01832	7/16 jic x 9/16 jic
01842	7/16 jic x 3/4 jic
01826	1/2 jic x 1/2 jic
01833	1/2 jic x 9/16 jic
01827	9/16 jic x 9/16 jic
01828	9/16 jic x 3/4 jic
01834	9/16 jic x 7/8 jic
01829	3/4 jic x 3/4 jic
01830	3/4 jic x 7/8 jic
01844	3/4 jic x 1-1/16 jic
01831	7/8 jic x 7/8 jic
01838	7/8 jic x 1-1/16 jic
01835	1-1/16 jic x 1-1/16 jic
01837	1-1/16 jic x 1-5/16 jic
01841	1-3/16 jic x 1-3/16 jic

Code	Description
01836	1-5/16 jic x 1-5/16 jic
01839	1-5/8 jic x 1-5/8 jic
01845	1-5/8 jic x 1-7/8 jic
01840	1-7/8 jic x 1-7/8 jic
01843	2-1/2 jic x 2-1/2 jic

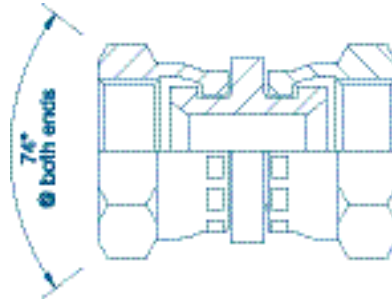

NPTF fixed female x BSP swivel female

Code	Description
90000	1/8 nptf x 1/8 bsp
90001	1/4 nptf x 1/4 bsp
90002	3/8 nptf x 3/8 bsp
90003	1/2 nptf x 1/2 bsp
90004	3/4 nptf x 3/4 bsp
90005	1 nptf x 1 bsp
90006	1-1/4 nptf x 1-1/4 bsp
90007	1-1/2 nptf x 1-1/2 bsp
90008	2 nptf x 2 bsp

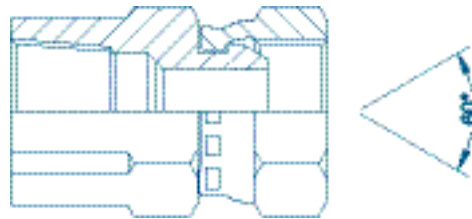

BSP swivel female x BSP swivel female BODIES ONLY

Code	Description
21725	1/8 bsp x 1/8 bsp
21726	1/8 bsp x 1/4 bsp
21727	1/4 bsp x 1/4 bsp
21728	1/4 bsp x 3/8 bsp
21729	3/8 bsp x 3/8 bsp
21733	3/8 bsp x 1/2 bsp
21734	1/2 bsp x 1/2 bsp
21747	1/2 bsp x 5/8 bsp
21735	1/2 bsp x 3/4 bsp
21738	5/8 bsp x 5/8 bsp
21741	3/4 bsp x 3/4 bsp
21742	3/4 bsp x 1 bsp

Code	Description
21743	1 bsp x 1 bsp
21745	1-1/4 bsp x 1-1/4 bsp
21748	1-1/2 bsp x 1-1/2 bsp

Due to ever increasing demand of crimped items, there may be long delays for these bodies.



Contents Section 4

Male x Fixed Female

-
- 48** BSP male x BSP fixed female extended
 - 48** BSP male 60° cone x BSP fixed female bush
 - 49** BSP male x BSP fixed female bush NOT CONED
 - 49** BSP male x BSP fixed female GAUGE
 - 50** BSP male x NPTF fixed female extended
 - 50** BSP male 60° cone x NPTF fixed female bush
 - 51** BSP male x BSPT fixed female extended
 - 51** BSP male 60° cone x BSPT fixed female bush
 - 51** BSP male x METRIC fixed female extended 1.5mm pitch
-
- 52** BSPT male x BSPT fixed female bush
 - 52** BSPT male x BSP fixed female extended
 - 53** BSPT male x BSP fixed female bush
 - 53** BSPT male x NPTF fixed female bush
 - 53** BSPT male x NPTF fixed female extended
-
- 54** NPTF male x NPTF fixed female bush
 - 54** NPTF male x NPTF fixed female extended
 - 55** NPTF male x BSP fixed female extended
 - 55** NPTF male x BSP fixed female bush
-
- 56** JIC male x JIC fixed female extended
 - 56** JIC male x BSP fixed female extended
 - 57** JIC male x NPTF fixed female extended
 - 57** JIC male x NPTF fixed female bush
 - 57** JIC male x BSP fixed female bush
-
- 58** SAE O'ring boss male x BSP fixed female bush
 - 58** SAE O'ring boss male x NPTF fixed female bush
-
- 58** METRIC male x METRIC fixed female extended 1.5mm pitch
 - 59** METRIC male 1.5mm pitch x BSP fixed female bush
 - 59** METRIC male 1.5mm pitch x BSP fixed female extended
 - 59** METRIC male 1.5mm pitch x NPTF fixed female bush

Fixed Female x Fixed Female

-
- 60** BSP fixed female x BSP fixed female
 - 60** BSP fixed female x BSP fixed female REDUCING
 - 60** BSPT fixed female x BSPT fixed female
 - 61** NPTF fixed female x BSP fixed female
 - 61** NPTF fixed female x NPTF fixed female
 - 61** NPTF fixed female x NPTF fixed female REDUCING
 - 62** NPTF fixed female x METRIC fixed female 1.5mm pitch
 - 62** NPTF fixed female x BSPT fixed female
 - 62** METRIC fixed female x METRIC fixed female 1.5mm pitch
 - 62** METRIC fixed female x METRIC fixed female 1.5mm pitch REDUCING
-

BSP male x BSP fixed female extended

Code	Description
00922	1/8 bsp x 1/8 bsp
00924	1/8 bsp x 1/4 bsp
00931	1/8 bsp x 3/8 bsp
00928	1/8 bsp x 1/2 bsp
00905	1/4 bsp x 1/8 bsp
00900	1/4 bsp x 1/4 bsp
00901	1/4 bsp x 3/8 bsp
00904	1/4 bsp x 1/2 bsp
00932	1/4 bsp x 3/4 bsp
00902	3/8 bsp x 1/4 bsp
00903	3/8 bsp x 3/8 bsp
00913	3/8 bsp x 1/2 bsp
00933	3/8 bsp x 3/4 bsp
00938	3/8 bsp x 1 bsp
00906	1/2 bsp x 3/8 bsp
00907	1/2 bsp x 1/2 bsp
00918	1/2 bsp x 3/4 bsp
00929	1/2 bsp x 1 bsp
00934	1/2 bsp x 1-1/4 bsp
00908	5/8 bsp x 1/2 bsp
00939	5/8 bsp x 3/4 bsp
00916	3/4 bsp x 1/2 bsp
00925	3/4 bsp x 5/8 bsp
00909	3/4 bsp x 3/4 bsp
00919	3/4 bsp x 1 bsp
00910	3/4 bsp x 1-1/4 bsp
00911	3/4 bsp x 1-1/2 bsp

Code	Description
00920	1 bsp x 3/4 bsp
00912	1 bsp x 1 bsp
00923	1 bsp x 1-1/4 bsp
00927	1 bsp x 1-1/2 bsp
00936	1 bsp x 2 bsp
00942	1 bsp x 3 bsp
00914	1-1/4 bsp x 1-1/4 bsp
00930	1-1/4 bsp x 1-1/2 bsp
00937	1-1/4 bsp x 2 bsp
00921	1-1/2 bsp x 1-1/4 bsp
00917	1-1/2 bsp x 1-1/2 bsp
00943	1-1/2 bsp x 2 bsp
00915	2 bsp x 2 bsp
00935	2 bsp x 2-1/2 bsp
00944	2 bsp x 3 bsp
00926	2-1/2 bsp x 2-1/2 bsp

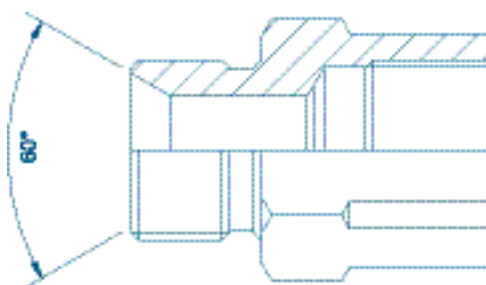

BSP male 60° cone x BSP fixed female bush

Code	Description
16167	3/8 bsp x 1/8 bsp
16166	1/2 bsp x 1/8 bsp
16150	1/2 bsp x 1/4 bsp
16151	5/8 bsp x 1/4 bsp
16152	3/4 bsp x 1/4 bsp
16153	3/4 bsp x 3/8 bsp
16156	1 bsp x 1/4 bsp
16168	1 bsp x 3/8 bsp
16157	1 bsp x 1/2 bsp
16147	1-1/4 bsp x 1/2 bsp
16158	1-1/4 bsp x 3/4 bsp
16162	1-1/4 bsp x 1 bsp
16529	1-1/2 bsp x 1/4 bsp
16149	1-1/2 bsp x 1/2 bsp
16159	1-1/2 bsp x 3/4 bsp
16160	1-1/2 bsp x 1 bsp
16527	2 bsp x 1/4 bsp
16528	2 bsp x 3/8 bsp

Code	Description
16146	2 bsp x 1/2 bsp
16526	2 bsp x 3/4 bsp
16161	2 bsp x 1 bsp
16164	2 bsp x 1-1/4 bsp
16163	2 bsp x 1-1/2 bsp
16165	2-1/2 bsp x 1-1/2 bsp
16154	2-1/2 bsp x 2 bsp
16148-16B	3 bsp x 1 bsp
16148	3 bsp x 1-1/2 bsp
16155	3 bsp x 2 bsp

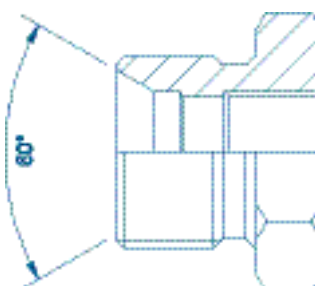

BSP male x BSP fixed female bush NOT CONED

Code	Description
00780	3/8 bsp x 1/8 bsp
00781	1/2 bsp x 1/8 bsp
00782	1/2 bsp x 1/4 bsp
00783	5/8 bsp x 1/4 bsp
00784	5/8 bsp x 3/8 bsp
00785	3/4 bsp x 1/8 bsp
00786	3/4 bsp x 1/4 bsp
00787	3/4 bsp x 3/8 bsp
00788	1 bsp x 1/4 bsp
00789	1 bsp x 3/8 bsp
00790	1 bsp x 1/2 bsp
00791	1 bsp x 5/8 bsp
00792	1-1/4 bsp x 1/4 bsp
00793	1-1/4 bsp x 3/8 bsp
00794	1-1/4 bsp x 1/2 bsp
00795	1-1/4 bsp x 3/4 bsp
00796	1-1/4 bsp x 1 bsp
00797	1-1/2 bsp x 1/4 bsp
00798	1-1/2 bsp x 3/8 bsp
00799	1-1/2 bsp x 1/2 bsp
00800	1-1/2 bsp x 5/8 bsp
00801	1-1/2 bsp x 3/4 bsp
00802	1-1/2 bsp x 1 bsp

Code	Description
00803	2 bsp x 1/4 bsp
00804	2 bsp x 3/8 bsp
00805	2 bsp x 1/2 bsp
00806	2 bsp x 5/8 bsp
00807	2 bsp x 3/4 bsp
00808	2 bsp x 1 bsp
00809	2 bsp x 1-1/4 bsp
00810	2 bsp x 1-1/2 bsp

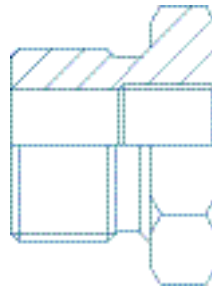

BSP male x BSP fixed female GAUGE

Code	Description
13309	1/8 bsp x 1/8 bsp
13310	1/8 bsp x 1/4 bsp
13311	1/8 bsp x 3/8 bsp
13312	1/4 bsp x 1/8 bsp
13300	1/4 bsp x 1/4 bsp
13304	1/4 bsp x 3/8 bsp
13307	1/4 bsp x 1/2 bsp
13313	3/8 bsp x 1/8 bsp
13308	3/8 bsp x 1/4 bsp
13301	3/8 bsp x 3/8 bsp
13303	3/8 bsp x 1/2 bsp
13305	1/2 bsp x 1/4 bsp
13306	1/2 bsp x 3/8 bsp
13302	1/2 bsp x 1/2 bsp
13314	1/2 bsp x 3/4 bsp
13315	1/2 bsp x 1 bsp
13316	3/4 bsp x 1/2 bsp
13317	1 bsp x 3/4 bsp

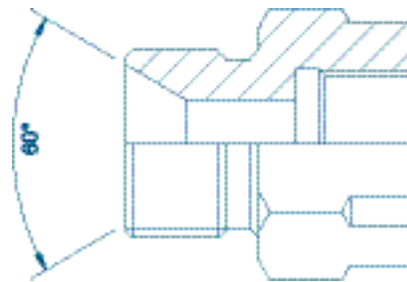

BSP male x NPTF fixed female extended

Code	Description
16060	1/8 bsp x 1/8 nptf
16064	1/8 bsp x 1/4 nptf
16061	1/4 bsp x 1/8 nptf
16062	1/4 bsp x 1/4 nptf
16073	1/4 bsp x 3/8 nptf
16085	1/4 bsp x 1/2 nptf
16072	3/8 bsp x 1/4 nptf
16063	3/8 bsp x 3/8 nptf
16065	1/2 bsp x 3/8 nptf
16066	1/2 bsp x 1/2 nptf
16082	1/2 bsp x 3/4 nptf
16067	3/4 bsp x 3/4 nptf
16076	3/4 bsp x 1 nptf
16083	1 bsp x 3/4 nptf
16068	1 bsp x 1 nptf
16084	1 bsp x 1-1/2 nptf
16069	1-1/4 bsp x 1-1/4 nptf
16088	1-1/4 bsp x 1-1/2 nptf
16075	1-1/2 bsp x 1-1/4 nptf
16070	1-1/2 bsp x 1-1/2 nptf
16071	2 bsp x 2 nptf

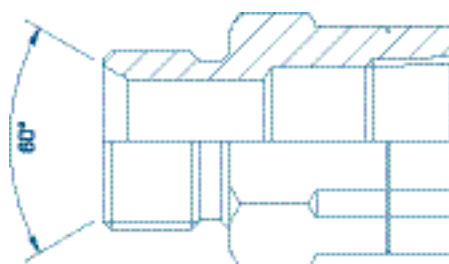

BSP male 60° cone x NPTF fixed female bush

Code	Description
16501	3/8 bsp x 1/8 nptf
16500	1/2 bsp x 1/8 nptf
16502	1/2 bsp x 1/4 nptf
16507	3/4 bsp x 1/4 nptf
16508	3/4 bsp x 3/8 nptf
16505	1 bsp x 1/8 nptf
16511	1 bsp x 1/4 nptf
16512	1 bsp x 3/8 nptf
16513	1 bsp x 1/2 nptf
16564	1-1/4 bsp x 1/4 nptf
16517	1-1/4 bsp x 1/2 nptf
16518	1-1/4 bsp x 3/4 nptf
16519	1-1/4 bsp x 1 nptf
16563	1-1/2 bsp x 1/2 nptf
16553	1-1/2 bsp x 3/4 nptf
16525	1-1/2 bsp x 1 nptf
16555	2 bsp x 3/8 nptf
16554	2 bsp x 1/2 nptf
16530	2 bsp x 3/4 nptf
16561	2 bsp x 1 nptf
16565	2 bsp x 1-1/4 nptf

Code	Description
16550	2-1/2 bsp x 1-1/2 nptf
16551	2-1/2 bsp x 2 nptf
16503	3 bsp x 1-1/2 nptf
16560	3 bsp x 2 nptf

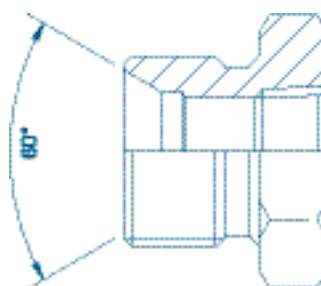

BSP male x BSPT fixed female extended

Code	Description
16091	1/4 bsp x 1/8 bspt
16090	1/4 bsp x 1/4 bspt
16108	1/4 bsp x 3/8 bspt
16092	3/8 bsp x 1/4 bspt
16093	3/8 bsp x 3/8 bspt
16089	3/8 bsp x 1/2 bspt
16106	1/2 bsp x 3/8 bspt
16094	1/2 bsp x 1/2 bspt
16102	3/4 bsp x 1/2 bspt
16095	3/4 bsp x 3/4 bspt
16103	3/4 bsp x 1 bspt
16107	1 bsp x 3/4 bspt
16096	1 bsp x 1 bspt
16097	1-1/4 bsp x 1-1/4 bspt
16098	1-1/2 bsp x 1-1/2 bspt
16101	2 bsp x 2 bspt

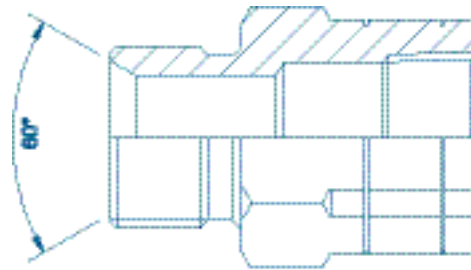

BSP male 60° cone x BSPT fixed female bush

Code	Description
16601	1/2 bsp x 1/4 bspt
16605	1 bsp x 1/4 bspt
16606	1 bsp x 3/8 bspt
16607	1 bsp x 1/2 bspt

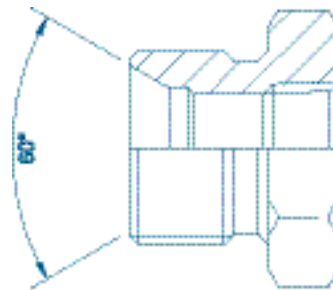

BSP male x METRIC fixed female extended 1.5mm pitch

Code	Description
19803	1/4 bsp x 12 mm
19804	1/4 bsp x 14 mm
19800	1/2 bsp x 16 mm
19801	1/2 bsp x 22 mm
19802	3/4 bsp x 22 mm

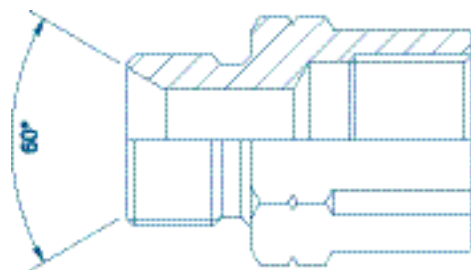

BSPT male x BSPT fixed female bush

Code	Description
16180	1/4 bspt x 1/8 bspt
16181	3/8 bspt x 1/8 bspt
16182	3/8 bspt x 1/4 bspt
16183	1/2 bspt x 1/4 bspt
16184	1/2 bspt x 3/8 bspt
16185	3/4 bspt x 1/4 bspt
16186	3/4 bspt x 3/8 bspt
16187	3/4 bspt x 1/2 bspt
16196	1 bspt x 1/4 bspt
16188	1 bspt x 3/8 bspt
16190	1 bspt x 1/2 bspt
16191	1 bspt x 3/4 bspt
16206	1-1/4 bspt x 1/2 bspt
16209	1-1/4 bspt x 1 bspt
16195	1-1/2 bspt x 1/2 bspt
16193	1-1/2 bspt x 1 bspt
16189	2 bspt x 1/2 bspt
16197	2 bspt x 3/4 bspt
16198	2 bspt x 1 bspt
16208	2 bspt x 1-1/4 bspt
16192	2 bspt x 1-1/2 bspt
16199	3 bspt x 2-1/2 bspt

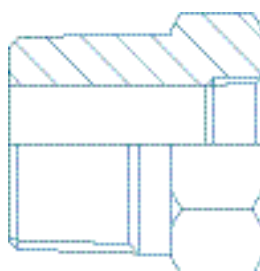

BSPT male x BSP fixed female extended

Code	Description
16119	1/8 bspt x 1/4 bsp
16135	1/4 bspt x 1/8 bsp
16120	1/4 bspt x 1/4 bsp
16118	1/4 bspt x 1/2 bsp
16129	3/8 bspt x 3/8 bsp
16114	3/8 bspt x 1/2 bsp
16139	1/2 bspt x 3/8 bsp
16130	1/2 bspt x 1/2 bsp
16131	3/4 bspt x 3/4 bsp
16132	1 bspt x 1 bsp
16133	1-1/4 bspt x 1-1/4 bsp
16134	1-1/2 bspt x 1-1/2 bsp
16140	2 bspt x 2 bsp

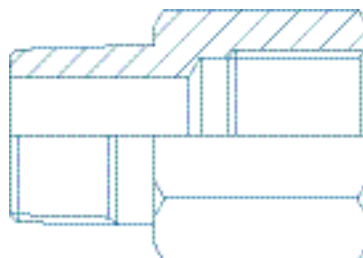

BSPT male x BSP fixed female bush

Code	Description
16121	3/8 bspt x 1/8 bsp
16122	3/8 bspt x 1/4 bsp
16125	1/2 bspt x 1/4 bsp
16123	3/4 bspt x 1/4 bsp
16124	3/4 bspt x 3/8 bsp
16137	3/4 bspt x 1/2 bsp
16126	1 bspt x 1/4 bsp
16117	1 bspt x 3/8 bsp
16127	1 bspt x 1/2 bsp
16128	1 bspt x 3/4 bsp
16133-08B	1-1/4 bspt x 1/2 bsp
16133-12B	1-1/4 bspt x 3/4 bsp
16136	1-1/4 bspt x 1 bsp
16142	1-1/2 bspt x 1/2 bsp
16143	1-1/2 bspt x 3/4 bsp

Code	Description
16144	1-1/2 bspt x 1 bsp
16138	1-1/2 bspt x 1-1/4 bsp
16115	2 bspt x 1/2 bsp
16141	2 bspt x 3/4 bsp
16140-16B	2 bspt x 1 bsp
16140-20B	2 bspt x 1-1/4 bsp
16116	2 bspt x 1-1/2 bsp

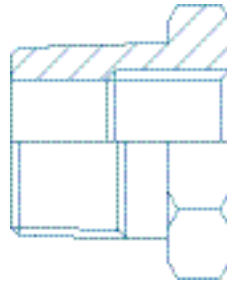

BSPT male x NPTF fixed female bush

Code	Description
18200	1/4 bspt x 1/8 nptf
18201	3/8 bspt x 1/8 nptf
18218	1/2 bspt x 1/4 nptf
18225	3/4 bspt x 1/4 nptf
18208	3/4 bspt x 3/8 nptf
18204	3/4 bspt x 1/2 nptf
18209	1 bspt x 1/4 nptf
18228	1 bspt x 1/2 nptf
18215	1-1/2 bspt x 3/4 nptf
18210	1-1/2 bspt x 1 nptf
18216	2 bspt x 3/4 nptf

Code	Description
18229	2 bspt x 1 nptf
18223	2 bspt x 1-1/4 nptf
18203	2-1/2 bspt x 2 nptf

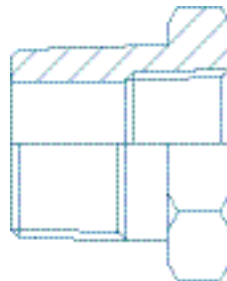

Other sizes in this range may be available on request.

BSPT male x NPTF fixed female extended

Code	Description
18205	1/8 bspt x 1/8 nptf
18206	1/4 bspt x 1/4 nptf
18220	1/4 bspt x 3/8 nptf
18219	1/4 bspt x 1/2 nptf
18207	3/8 bspt x 3/8 nptf
18221	1/2 bspt x 3/8 nptf
18222	1/2 bspt x 1/2 nptf
18211	3/4 bspt x 3/4 nptf
18212	1 bspt x 3/4 nptf
18217	1 bspt x 1 nptf
18226	1-1/2 bspt x 1-1/2 nptf

Code	Description
18213	2 bspt x 1-1/2 nptf
18214	2 bspt x 2 nptf
18224	2-1/2 bspt x 2-1/2 nptf

Other sizes in this range may be available on request.

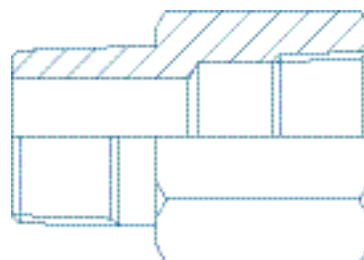

NPTF male x NPTF fixed female bush

Code	Description
01001	1/4 nptf x 1/8 nptf
01002	3/8 nptf x 1/8 nptf
01003	3/8 nptf x 1/4 nptf
01018	1/2 nptf x 1/8 nptf
01004	1/2 nptf x 1/4 nptf
01005	1/2 nptf x 3/8 nptf
01032	3/4 nptf x 1/8 nptf
01006	3/4 nptf x 1/4 nptf
01007	3/4 nptf x 3/8 nptf
01008	3/4 nptf x 1/2 nptf
01022	1 nptf x 1/4 nptf
01011	1 nptf x 3/8 nptf
01009	1 nptf x 1/2 nptf
01010	1 nptf x 3/4 nptf
01023	1-1/4 nptf x 1/4 nptf
01025	1-1/4 nptf x 3/8 nptf
01026	1-1/4 nptf x 1/2 nptf
01019	1-1/4 nptf x 3/4 nptf
01012	1-1/4 nptf x 1 nptf
01024	1-1/2 nptf x 1/4 nptf
01027	1-1/2 nptf x 3/8 nptf
01028	1-1/2 nptf x 1/2 nptf
01013	1-1/2 nptf x 3/4 nptf

Code	Description
01015	1-1/2 nptf x 1 nptf
01021	1-1/2 nptf x 1-1/4 nptf
01031	2 nptf x 1/4 nptf
01035	2 nptf x 3/8 nptf
01030	2 nptf x 1/2 nptf
01029	2 nptf x 3/4 nptf
01014	2 nptf x 1 nptf
01017	2 nptf x 1-1/4 nptf
01016	2 nptf x 1-1/2 nptf
01038	2-1/2 nptf x 1-1/4 nptf
01033	2-1/2 nptf x 2 nptf
01037	3 nptf x 1-1/4 nptf
01036	3 nptf x 2 nptf

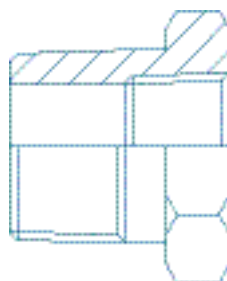

NPTF male x NPTF fixed female extended

Code	Description
00820	1/8 nptf x 1/8 nptf
00821	1/8 nptf x 1/4 nptf
00822	1/4 nptf x 1/4 nptf
00823	1/4 nptf x 3/8 nptf
00843	1/4 nptf x 1 nptf
00857	3/8 nptf x 1/4 nptf
00824	3/8 nptf x 3/8 nptf
00842	3/8 nptf x 1/2 nptf
00841	3/8 nptf x 3/4 nptf
00854	3/8 nptf x 1 nptf
00826	1/2 nptf x 1/2 nptf
00850	1/2 nptf x 3/4 nptf
00837	1/2 nptf x 1 nptf
00829	3/4 nptf x 3/4 nptf
00844	3/4 nptf x 1 nptf
00849	3/4 nptf x 1-1/4 nptf
00831	1 nptf x 1 nptf
00825	1 nptf x 1-1/4 nptf
00851	1 nptf x 1-1/2 nptf
00852	1 nptf x 2 nptf

Code	Description
00833	1-1/4 nptf x 1-1/4 nptf
00834	1-1/4 nptf x 1-1/2 nptf
00828	1-1/4 nptf x 2 nptf
00839	1-1/2 nptf x 1-1/2 nptf
00840	1-1/2 nptf x 2 nptf
00835	2 nptf x 2 nptf
00853	2 nptf x 2-1/2 nptf
00855	2-1/2 nptf x 2-1/2 nptf

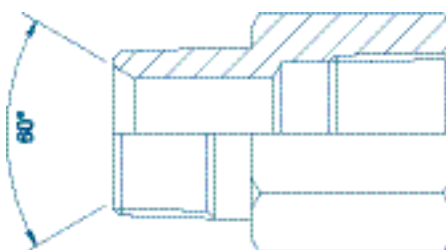

NPTF male x BSP fixed female extended

Code	Description
16170	1/8 nptf x 1/8 bsp
16178	1/8 nptf x 1/4 bsp
16171	1/4 nptf x 1/4 bsp
16173	3/8 nptf x 3/8 bsp
16172	1/2 nptf x 3/8 bsp
16174	1/2 nptf x 1/2 bsp
16175	3/4 nptf x 3/4 bsp
16176	1 nptf x 1 bsp
16169	1-1/4 nptf x 1-1/4 bsp
16366	1-1/2 nptf x 1-1/4 bsp
16179	1-1/2 nptf x 1-1/2 bsp
16177	2 nptf x 2 bsp

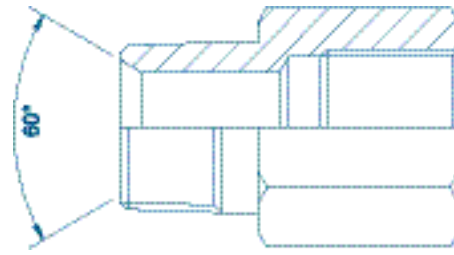

NPTF male x BSP fixed female bush

Code	Description
16350	1/4 nptf x 1/8 bsp
16351	3/8 nptf x 1/4 bsp
16352	1/2 nptf x 1/4 bsp
16354	3/4 nptf x 1/4 bsp
16355	3/4 nptf x 3/8 bsp
16356	3/4 nptf x 1/2 bsp
16357	1 nptf x 1/4 bsp
16358	1 nptf x 3/8 bsp
16359	1 nptf x 1/2 bsp
16360	1 nptf x 3/4 bsp
16374	1-1/4 nptf x 1/4 bsp
16367	1-1/4 nptf x 1/2 bsp
16372	1-1/4 nptf x 3/4 bsp
16369	1-1/4 nptf x 1 bsp
16375	1-1/2 nptf x 1/2 bsp
16370	1-1/2 nptf x 3/4 bsp
16368	1-1/2 nptf x 1 bsp
16365	2 nptf x 1 bsp
16362	2 nptf x 1-1/4 bsp
16373	2 nptf x 1-1/2 bsp
16361	2-1/2 nptf x 1-1/2 bsp
16349	2-1/2 nptf x 2 bsp
16364	3 nptf x 1 bsp
16371	3 nptf x 1-1/4 bsp
16363	3 nptf x 2 bsp

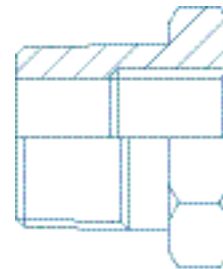

JIC male x JIC fixed female extended

Code	Description
4015-04-06	7/16 jic x 9/16 jic
4015-04-08	7/16 jic x 3/4 jic
4015-04-12	7/16 jic x 1-1/16 jic
4015-06-08	9/16 jic x 3/4 jic
4015-06-10	9/16 jic x 7/8 jic
4015-06-14	9/16 jic x 1-3/16 jic
4015-08-10	3/4 jic x 7/8 jic
4015-08-12	3/4 jic x 1-1/16 jic
4015-08-16	3/4 jic x 1-5/16 jic
4015-12-16	1-1/16 jic x 1-5/16 jic
4015-16-20	1-5/16 jic x 1-5/8 jic
4015-16-24	1-5/16 jic x 1-7/8 jic

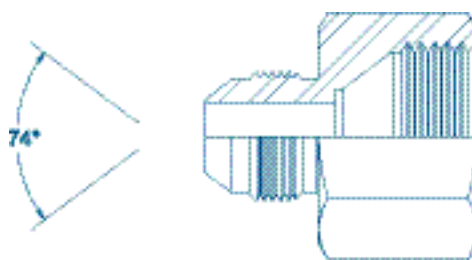

JIC male x BSP fixed female extended

Code	Description
17004	7/16 jic x 1/8 bsp
17001	7/16 jic x 1/4 bsp
17002	7/16 jic x 3/8 bsp
17000	9/16 jic x 1/4 bsp
17010	9/16 jic x 3/8 bsp
17012	9/16 jic x 1/2 bsp
17003	3/4 jic x 3/8 bsp
17005	3/4 jic x 1/2 bsp
17013	3/4 jic x 5/8 bsp
17014	3/4 jic x 3/4 bsp
17009	7/8 jic x 1/2 bsp
17015	7/8 jic x 5/8 bsp
17016	7/8 jic x 3/4 bsp
17007	1-1/16 jic x 1/2 bsp
17008	1-1/16 jic x 3/4 bsp
17017	1-1/16 jic x 1 bsp
17006	1-5/16 jic x 1 bsp
17018	1-5/8 jic x 1-1/4 bsp
17019	1-7/8 jic x 1-1/2 bsp
17020	2-1/2 jic x 2 bsp

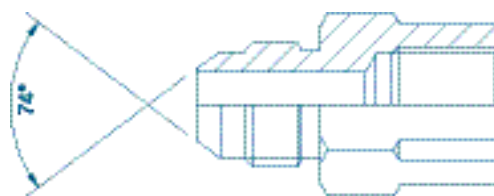

Other sizes in this range may be available on request.

JIC male x NPTF fixed female extended

Code	Description
16261	7/16 jic x 1/8 nptf
16250	7/16 jic x 1/4 nptf
16249	7/16 jic x 3/8 nptf
16251	9/16 jic x 1/4 nptf
16257	9/16 jic x 3/8 nptf
16258	9/16 jic x 1/2 nptf
16248	3/4 jic x 1/4 nptf
16256	3/4 jic x 3/8 nptf
16252	3/4 jic x 1/2 nptf
16247	3/4 jic x 3/4 nptf
16253	7/8 jic x 1/2 nptf
16254	1-1/16 jic x 3/4 nptf
16265	1-1/16 jic x 1 nptf
16255	1-5/16 jic x 1 nptf
16260	1-5/8 jic x 1-1/4 nptf
16259	2-1/2 jic x 2 nptf

Other sizes in this range may be available on request.

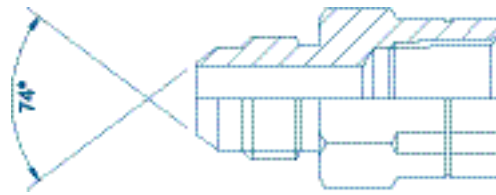

JIC male x NPTF fixed female bush

Code	Description
17153	7/8 jic x 3/8 nptf
17150	1-5/16 jic x 1/4 nptf
17151	1-5/8 jic x 3/4 nptf
17152	1-7/8 jic x 1 nptf

Other sizes in this range may be available on request.

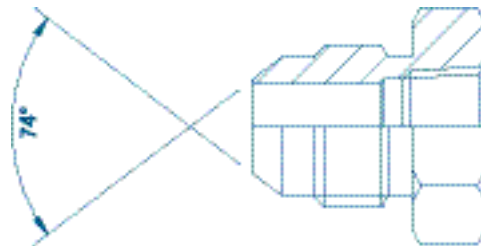

JIC male x BSP fixed female bush

Code	Description
17040	9/16 jic x 1/8 bsp
17041	3/4 jic x 1/8 bsp
17022	1-5/8 jic x 1/2 bsp
17042	1-5/8 jic x 1 bsp
17023	1-7/8 jic x 1/2 bsp
17024	2-1/2 jic x 1/2 bsp
17021	2-1/2 jic x 1 bsp

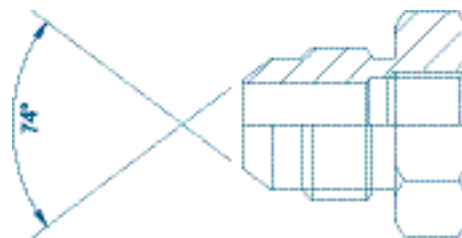

SAE O'ring boss male x BSP fixed female bush

Code	Description
17200	3/4 sorb x 1/8 bsp
17202	1-3/16 sorb x 3/8 bsp
17207	1-5/16 sorb x 1/4 bsp
17201	1-5/16 sorb x 3/8 bsp

Other sizes in this range may be available on request.

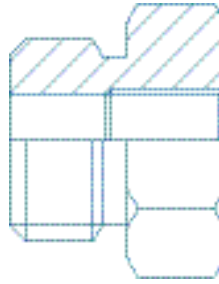

SAE O'ring boss male x NPTF fixed female bush

Code	Description
17300	3/4 sorb x 1/8 nptf
17301	1-1/16 sorb x 3/8 nptf

Other sizes in this range may be available on request.

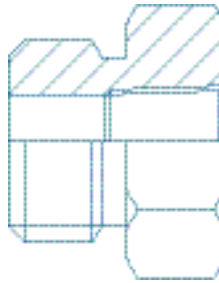

METRIC male x METRIC fixed female extended 1.5mm pitch

Code	Description
17409	12 mm x 12 mm
17402	14 mm x 14 mm
17403	14 mm x 16 mm
17400	16 mm x 12 mm
17405	16 mm x 18 mm
17404	16 mm x 20 mm
17401	16 mm x 22 mm
17406	22 mm x 16 mm
17407	24 mm x 18 mm

Other sizes in this range may be available on request.

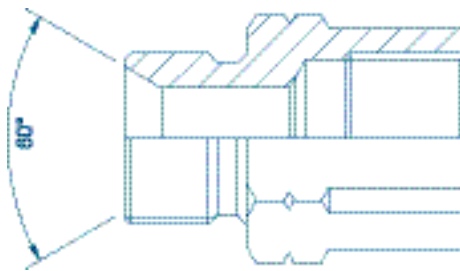

METRIC male 1.5mm pitch x BSP fixed female bush

Code	Description
17450	16 mm x 1/8 bsp
17454	18 mm x 1/4 bsp
17462	20 mm x 1/4 bsp
17463	22 mm x 1/8 bsp
17451	22 mm x 1/4 bsp
17452	22 mm x 3/8 bsp
17470	24 mm x 1/4 bsp
17461	26 mm x 1/4 bsp
17464	26 mm x 3/8 bsp
17467	30 mm x 1/2 bsp



Other sizes in this range may be available on request.

METRIC male 1.5mm pitch x BSP fixed female extended

Code	Description
17456	12 mm x 3/8 bsp
17457	12 mm x 1/2 bsp
17458	16 mm x 3/8 bsp
17455	16 mm x 1/2 bsp
17459	18 mm x 1/4 bsp
17465	18 mm x 3/8 bsp
17460	22 mm x 1/2 bsp
17453	26 mm x 1/2 bsp

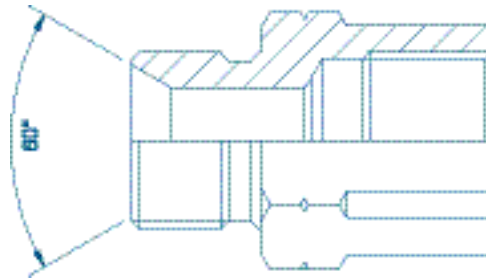

Other sizes in this range may be available on request.

METRIC male 1.5mm pitch x NPTF fixed female bush

Code	Description
17500	16 mm x 1/8 nptf
17501	16 mm x 1/4 nptf
17502	18 mm x 1/8 nptf
17512	22 mm x 1/8 nptf
17509	22 mm x 1/4 nptf
17503	24 mm x 3/8 nptf
17513	26 mm x 1/8 nptf
17505	26 mm x 3/8 nptf



Other sizes in this range may be available on request.

BSP fixed female x BSP fixed female

Code	Description
09000	1/8 bsp
09002	1/4 bsp
09004	3/8 bsp
09005	1/2 bsp
09009	5/8 bsp
09010	3/4 bsp
09011	1 bsp
09012	1-1/4 bsp
09013	1-1/2 bsp
09014	2 bsp
09019	2-1/2 bsp
08998	3 bsp

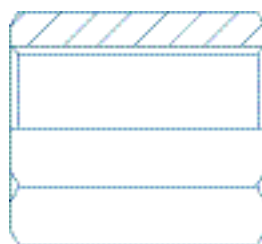

BSP fixed female x BSP fixed female REDUCING

Code	Description
09001	1/8 bsp x 1/4 bsp
08996	1/8 bsp x 3/8 bsp
08995	1/8 bsp x 1/2 bsp
09003	1/4 bsp x 3/8 bsp
09016	1/4 bsp x 1/2 bsp
09024	1/4 bsp x 3/4 bsp
09006	3/8 bsp x 1/2 bsp
09021	3/8 bsp x 3/4 bsp
09008	1/2 bsp x 5/8 bsp
09007	1/2 bsp x 3/4 bsp
09017	1/2 bsp x 1 bsp
09015	3/4 bsp x 1 bsp
08997	3/4 bsp x 1-1/4 bsp
09018	1 bsp x 1-1/4 bsp
09023	1 bsp x 1-1/2 bsp
09022	1-1/4 bsp x 1-1/2 bsp
09020	1-1/2 bsp x 2 bsp

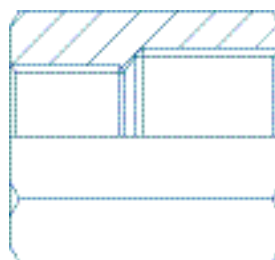

BSPT fixed female x BSPT fixed female

Code	Description
90201	1/4 bspt
90205	3/4 bspt
90206	1 bspt

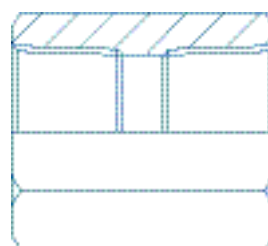

NPTF fixed female x BSP fixed female

Code	Description
90051	1/4 nptf x 1/4 bsp
90052	1/4 nptf x 3/8 bsp
90056	1/4 nptf x 1/2 bsp
90058	3/8 nptf x 3/8 bsp
90057	3/8 nptf x 1/2 bsp
90055	1/2 nptf x 3/8 bsp
90053	1/2 nptf x 1/2 bsp
90054	1/2 nptf x 3/4 bsp

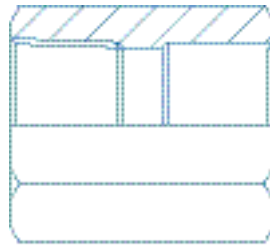

NPTF fixed female x NPTF fixed female

Code	Description
08095	1/8 nptf
08096	1/4 nptf
08094	3/8 nptf
08097	1/2 nptf
08099	3/4 nptf
08098	1 nptf
08101	1-1/4 nptf
08102	1-1/2 nptf
08093	2 nptf
08112	2-1/2 nptf
08089	3 nptf

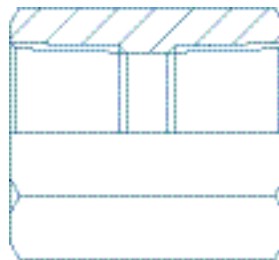

NPTF fixed female x NPTF fixed female REDUCING

Code	Description
08090	1/8 nptf x 1/4 nptf
08106	1/8 nptf x 3/8 nptf
08091	1/4 nptf x 3/8 nptf
08103	1/4 nptf x 1/2 nptf
08100	3/8 nptf x 1/2 nptf
08111	1/2 nptf x 3/4 nptf
08092	3/4 nptf x 1 nptf
08107	1 nptf x 1-1/4 nptf
08105	1 nptf x 1-1/2 nptf
08104	1 nptf x 2 nptf
08108	1-1/4 nptf x 1-1/2 nptf

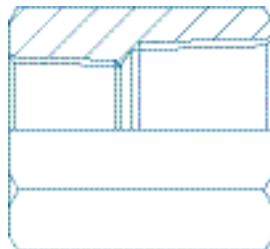

NPTF fixed female x METRIC fixed female 1.5mm pitch

Code	Description
90101	1/4 nptf x 12 mm
90102	1/4 nptf x 14 mm
90103	1/4 nptf x 16 mm

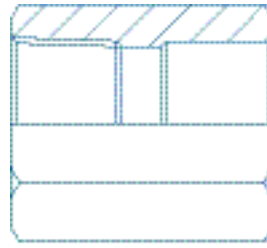

NPTF fixed female x BSPT fixed female

Code	Description
08401	3/8 nptf x 3/8 bspt
08402	1/2 nptf x 1/2 bspt
08403	3/4 nptf x 3/4 bspt
08404	1 nptf x 1 bspt
08405	1-1/4 nptf x 1-1/4 bspt
08406	1-1/2 nptf x 1-1/2 bspt
08407	2 nptf x 2 bspt
08408	2-1/2 nptf x 2-1/2 bspt
08409	3 nptf x 3 bspt
08410	4 nptf x 4 bspt

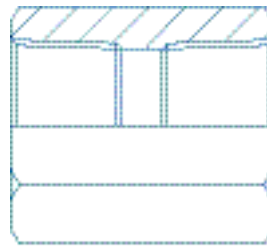

METRIC fixed female x METRIC fixed female 1.5mm pitch

Code	Description
19012	10 mm
19000	12 mm
19001	14 mm
19002	16 mm
19003	18 mm
19011	20 mm
19004	22 mm

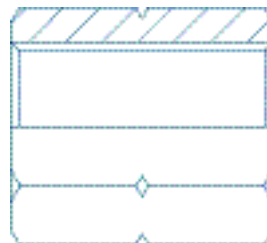

METRIC fixed female x METRIC fixed female 1.5mm pitch REDUCING

Code	Description
19009	16 mm x 12 mm
19010	22 mm x 16 mm

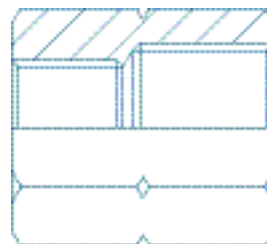

Contents Section 5

Male Tees

64	BSP male tee cone seating
64	BSP male tee cone seating ENLARGING ON BRANCH
64	BSP male tee cone seating UNEQUAL
64	BSP male tee for bonded seal
65	BSP male tee for bonded seal REDUCING ON BRANCH
65	BSP male tee for bonded seal ENLARGING ON BRANCH
65	BSP male UNEQUAL tee for bonded seal
66	BSP male tee for bonded seal HEXAGON INSERT
66	NPTF male tee
66	JIC male tee
67	JIC male tee ENLARGING ON BRANCH

Male x Male x Female Tees

67	BSP male x BSP male x BSP swivel female branch tee
67	BSP male x BSP male x BSP swivel female branch tee REDUCING ON BRANCH
67	BSP male x BSP male x BSP swivel female branch tee ENLARGING ON BRANCH
68	BSP male x BSP male x BSP swivel female branch UNEQUAL tee
68	JIC male x JIC male x JIC swivel female branch tee

Male x Female x Male Tees

68	BSP male x BSP swivel female x BSP male branch tee
69	BSP male x BSP swivel female x BSP male branch tee REDUCING ON BRANCH
69	BSP male x BSP swivel female x BSP male branch tee ENLARGING ON BRANCH
69	NPTF male x NPTF fixed female x NPTF male branch tee
70	JIC male x JIC swivel female x JIC male branch tee

Male x Female x Female Tees

70	BSP male x BSP swivel female x BSP swivel female branch tee
70	BSP male x BSP swivel female x BSP swivel female branch tee ENLARGING ON BRANCH
71	BSP male x BSP swivel female x BSP swivel female tee REDUCING ON BRANCH
71	NPTF male x NPTF fixed female x NPTF fixed female branch tee
71	JIC male x JIC swivel female x JIC swivel female branch tee

Female x Female x Male Tees

72	BSP swivel female x BSP swivel female x BSP male branch tee
72	BSP swivel female x BSP swivel female x BSP male branch tee REDUCING ON BRANCH
72	NPTF fixed female x NPTF fixed female x NPTF male branch tee
73	JIC swivel female x JIC swivel female x JIC male branch tee

Female x Female x Female Tees

73	BSP swivel female tee
73	BSP swivel female tee REDUCING ON BRANCH
73	BSP swivel female tee ENLARGING ON BRANCH
74	BSP fixed female tee
74	NPTF fixed female tee
74	JIC swivel female tee

Crosses

75	BSP male cross for bonded seal
75	JIC male cross
75	BSP swivel female cross
76	BSP fixed female cross
76	NPTF fixed female cross
76	NPTF male cross

BSP male tee cone seating

Code	Description
01901	1/4 bsp
01902	3/8 bsp
01903	1/2 bsp
01905	3/4 bsp
01906	1 bsp
01908	1-1/2 bsp
01909	2 bsp

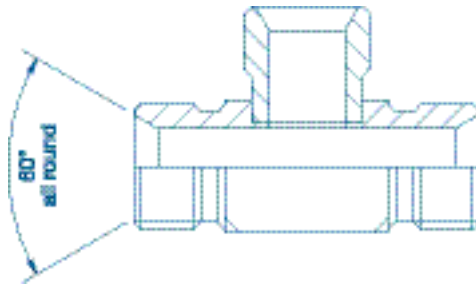

BSP male tee cone seating ENLARGING ON BRANCH

Code	Description
01911	1/4 bsp x 1/4 bsp x 3/8 bsp
01913	3/8 bsp x 3/8 bsp x 1/2 bsp

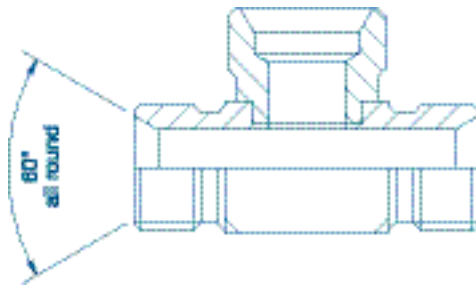

BSP male tee cone seating UNEQUAL

Code	Description
01900	3/4 bsp x 1 bsp x 3/4 bsp

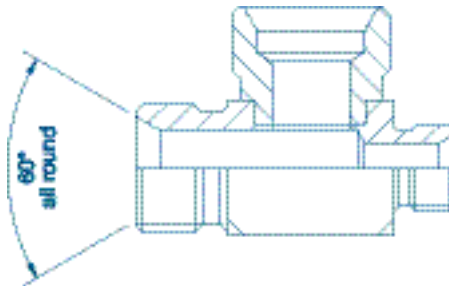

BSP male tee for bonded seal

Code	Description
01932	1/8 bsp
01925	1/4 bsp
01926	3/8 bsp
01927	1/2 bsp
01928	5/8 bsp
01929	3/4 bsp
01930	1 bsp
01931	1-1/4 bsp
01938	1-1/2 bsp
01939	2 bsp

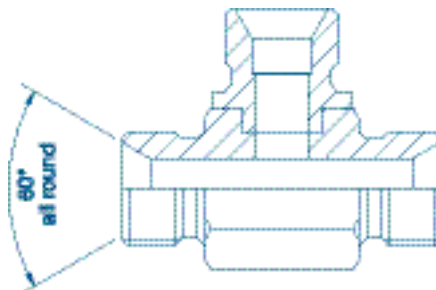

BSP male tee for bonded seal REDUCING ON BRANCH

Code	Description
01910	1/4 bsp x 1/4 bsp x 1/8 bsp
01912	3/8 bsp x 3/8 bsp x 1/4 bsp
01914	1/2 bsp x 1/2 bsp x 1/4 bsp
01915	1/2 bsp x 1/2 bsp x 3/8 bsp
01916	5/8 bsp x 5/8 bsp x 1/2 bsp
01917	3/4 bsp x 3/4 bsp x 1/4 bsp
01918	3/4 bsp x 3/4 bsp x 3/8 bsp
01919	3/4 bsp x 3/4 bsp x 1/2 bsp
01920	3/4 bsp x 3/4 bsp x 5/8 bsp
01923	1 bsp x 1 bsp x 1/4 bsp
01924	1 bsp x 1 bsp x 3/8 bsp
01921	1 bsp x 1 bsp x 1/2 bsp
01922	1 bsp x 1 bsp x 3/4 bsp
01936	1-1/4 bsp x 1-1/4 bsp x 3/4 bsp
01934	1-1/4 bsp x 1-1/4 bsp x 1 bsp

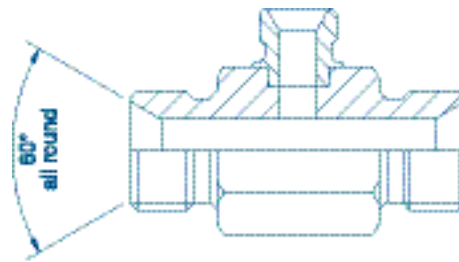

BSP male tee for bonded seal ENLARGING ON BRANCH

Code	Description
01942	3/8 bsp x 3/8 bsp x 1/2 bsp
01935	1/2 bsp x 1/2 bsp x 3/4 bsp

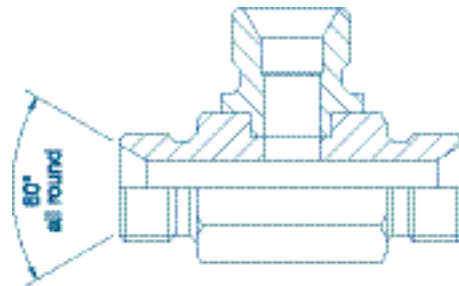

BSP male UNEQUAL tee for bonded seal

Code	Description
01944	1/2 bsp x 3/4 bsp x 1/2 bsp
01941	1/2 bsp x 3/4 bsp x 3/4 bsp

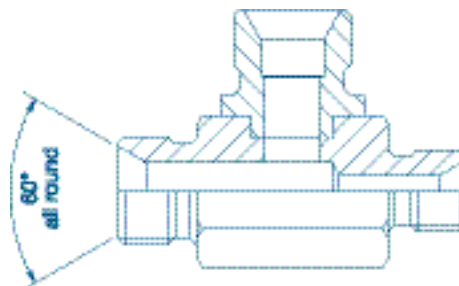

BSP male tee for bonded seal HEXAGON INSERT

Code	Description
01926HI	3/8 bsp
01927HI	1/2 bsp

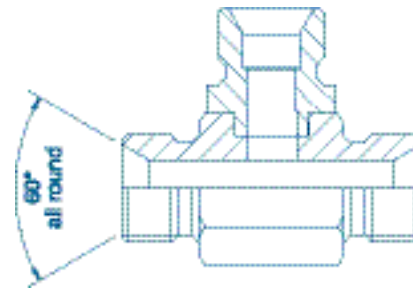

NPTF male tee

Code	Description
07090	1/8 nptf
07091	1/4 nptf
07092	3/8 nptf
07093	1/2 nptf
07094	3/4 nptf
07095	1 nptf
07096	1-1/4 nptf
07088	1-1/2 nptf
07089	2 nptf

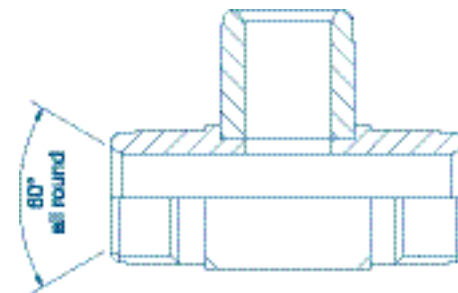

JIC male tee

Code	Description
01949	3/8 jic
01950	7/16 jic
01951	1/2 jic
01952	9/16 jic
01953	3/4 jic
01954	7/8 jic
01955	1-1/16 jic
01956	1-3/16 jic
01957	1-5/16 jic
01958	1-5/8 jic
01959	1-7/8 jic
01966	2-1/2 jic

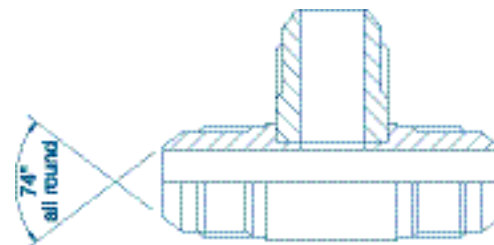

Now available as forged. See Section 10.

JIC male tee ENLARGING ON BRANCH

Code	Description
01961	7/16 jic x 7/16 jic x 9/16 jic
01962	9/16 jic x 9/16 jic x 3/4 jic
01963	3/4 jic x 3/4 jic x 1-1/16 jic
01964	1-1/16 jic x 1-1/16 jic x 1-5/16 jic
01965	1-5/16 jic x 1-5/16 jic x 1-5/8 jic

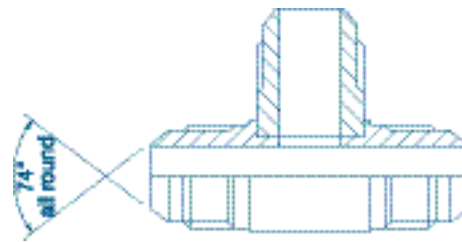

BSP male x BSP male x BSP swivel female branch tee

Code	Description
02000	1/8 bsp
02001	1/4 bsp
02002	3/8 bsp
02003	1/2 bsp
02004	5/8 bsp
02005	3/4 bsp
02006	1 bsp
02007	1-1/4 bsp
02012	1-1/2 bsp

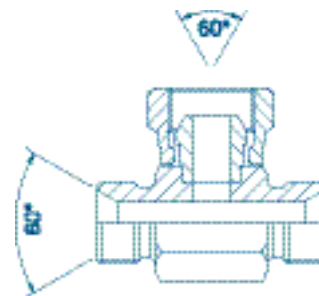

Parts with O'ring now available on request.

BSP male x BSP male x BSP swivel female branch tee REDUCING ON BRANCH

Code	Description
02010	3/8 bsp x 3/8 bsp x 1/4 bsp
02015	1/2 bsp x 1/2 bsp x 1/4 bsp
02008	1/2 bsp x 1/2 bsp x 3/8 bsp
02016	3/4 bsp x 3/4 bsp x 1/2 bsp

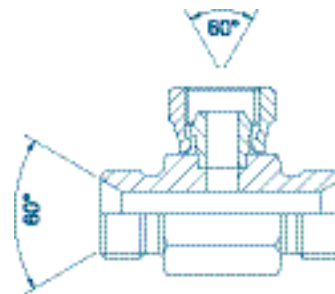

BSP male x BSP male x BSP swivel female branch tee ENLARGING ON BRANCH

Code	Description
02009	1/4 bsp x 1/4 bsp x 3/8 bsp
02011	3/8 bsp x 3/8 bsp x 1/2 bsp

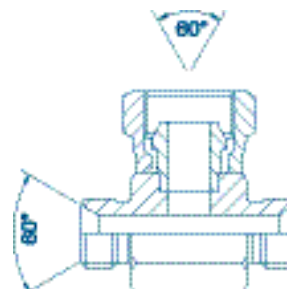

BSP male x BSP male x BSP swivel female branch UNEQUAL tee

Code	Description
02014	1/4 bsp x 1/2 bsp x 1/2 bsp
01998	3/8 bsp x 1/2 bsp x 1/2 bsp
01999	1/2 bsp x 3/4 bsp x 3/4 bsp
02013	1/2 bsp x 3/4 bsp x 1 bsp

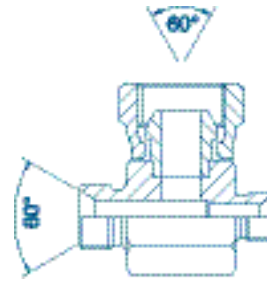

JIC male x JIC male x JIC swivel female branch tee

Code	Description
02053	7/16 jic
02056	1/2 jic
02050	9/16 jic
02051	3/4 jic
02052	7/8 jic
02054	1-1/16 jic
02055	1-5/16 jic
02048	1-5/8 jic
02040	1-7/8 jic
02041	2-1/2 jic

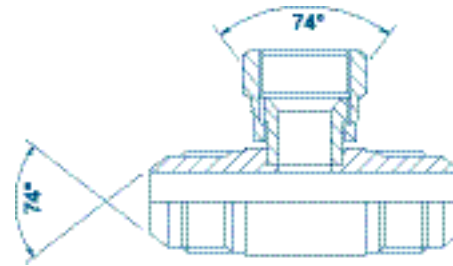

Now available as forged. See Section 10.

BSP male x BSP swivel female x BSP male branch tee

Code	Description
02033	1/8 bsp
02025	1/4 bsp
02026	3/8 bsp
02027	1/2 bsp
02028	5/8 bsp
02029	3/4 bsp
02030	1 bsp
02034	1-1/4 bsp
02020	1-1/2 bsp
02021	2 bsp

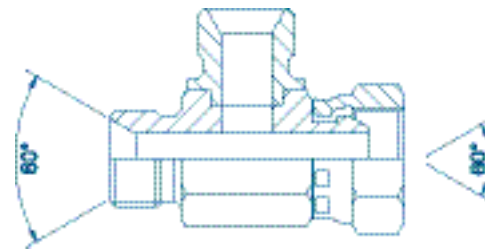

Parts with O'ring on female now available on request.

BSP male x BSP swivel female x BSP male branch tee REDUCING ON BRANCH

Code	Description
02035	3/8 bsp x 3/8 bsp x 1/4 bsp
02036	3/8 bsp x 1/2 bsp x 1/2 bsp
02032	1/2 bsp x 1/2 bsp x 1/4 bsp
02031	1/2 bsp x 1/2 bsp x 3/8 bsp
02022	3/4 bsp x 3/4 bsp x 1/4 bsp
02039	3/4 bsp x 3/4 bsp x 3/8 bsp
02037	3/4 bsp x 3/4 bsp x 1/2 bsp
02023	1 bsp x 1 bsp x 1/4 bsp
02038	1 bsp x 1 bsp x 1/2 bsp
02018	1 bsp x 1 bsp x 3/4 bsp

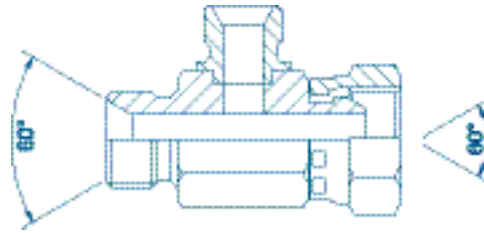

BSP male x BSP swivel female x BSP male branch tee ENLARGING ON BRANCH

Code	Description
02017	3/8 bsp x 3/8 bsp x 1/2 bsp

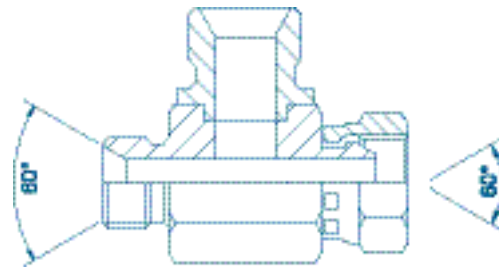

NPTF male x NPTF fixed female x NPTF male branch tee

Code	Description
08010	1/4 nptf
08011	3/8 nptf
08012	1/2 nptf
08013	3/4 nptf
08014	1 nptf
08015	1-1/4 nptf
08016	1-1/2 nptf

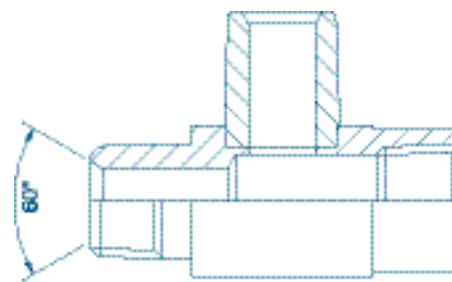

JIC male x JIC swivel female x JIC male branch tee

Code	Description
12040	7/16 jic
12041	1/2 jic
12042	9/16 jic
12043	3/4 jic
12044	7/8 jic
12045	1-1/16 jic
12046	1-5/16 jic
12047	1-5/8 jic
12048	1-7/8 jic
12050	2-1/2 jic

Now available as forged. See Section 10.

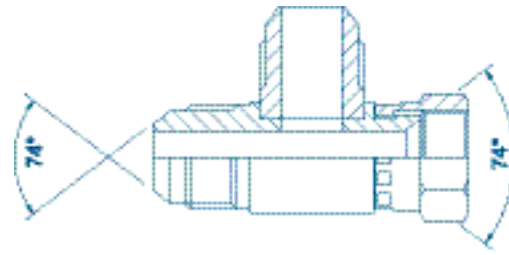

BSP male x BSP swivel female x BSP swivel female branch tee

Code	Description
09625	1/8 bsp
09626	1/4 bsp
09627	3/8 bsp
09628	1/2 bsp
09629	5/8 bsp
09630	3/4 bsp
09631	1 bsp
09632	1-1/4 bsp

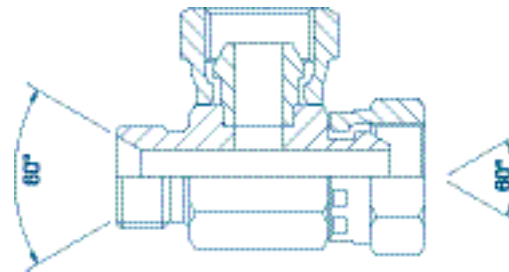

BSP male x BSP swivel female x BSP swivel female branch tee ENLARGING ON BRANCH

Code	Description
09633	3/8 bsp x 3/8 bsp x 1/2 bsp

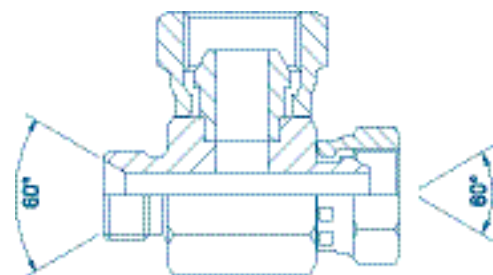

BSP male x BSP swivel female x BSP swivel female tee REDUCING ON BRANCH

Code	Description
09634	3/8 bsp x 3/8 bsp x 1/4 bsp
09637	3/4 bsp x 3/4 bsp x 1/4 bsp

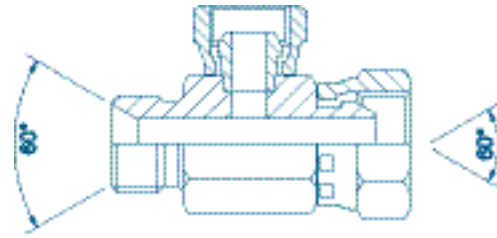

NPTF male x NPTF fixed female x NPTF fixed female branch tee

Code	Description
07059	1/8 nptf
07060	1/4 nptf
07061	3/8 nptf
07062	1/2 nptf
07063	3/4 nptf
07064	1 nptf
07065	1-1/4 nptf
07066	1-1/2 nptf

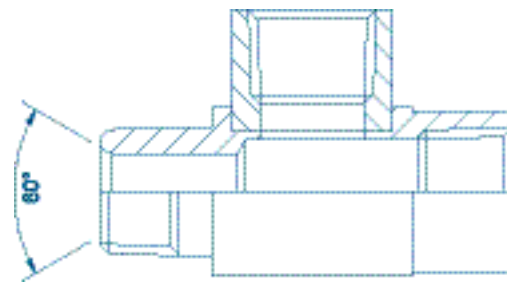

JIC male x JIC swivel female x JIC swivel female branch tee

Code	Description
02057	7/16 jic
02058	1/2 jic
02059	9/16 jic
02060	3/4 jic
02061	7/8 jic
02062	1-1/16 jic
02063	1-5/16 jic

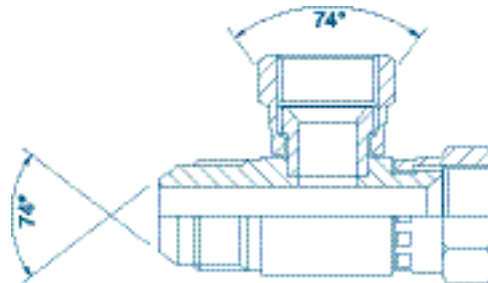

BSP swivel female x BSP swivel female x BSP male branch tee

Code	Description
02070	1/4 bsp
02071	3/8 bsp
02072	1/2 bsp
02073	5/8 bsp
02074	3/4 bsp
02075	1 bsp
02076	1-1/4 bsp

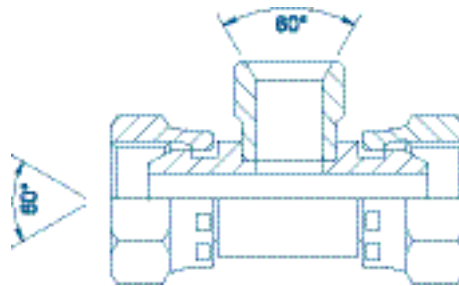

BSP swivel female x BSP swivel female x BSP male branch tee REDUCING ON BRANCH

Code	Description
02080	3/8 bsp x 3/8 bsp x 1/4 bsp
02078	1/2 bsp x 1/2 bsp x 1/4 bsp
02082	3/4 bsp x 3/4 bsp x 1/4 bsp
02081	3/4 bsp x 3/4 bsp x 3/8 bsp
02077	3/4 bsp x 3/4 bsp x 1/2 bsp
02083	1 bsp x 1 bsp x 1/2 bsp
02079	1 bsp x 1 bsp x 3/4 bsp

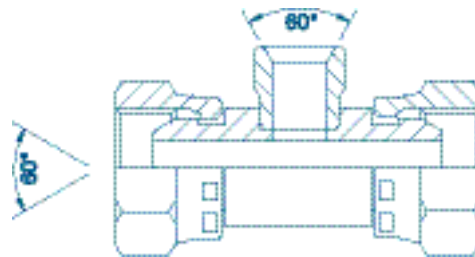

NPTF fixed female x NPTF fixed female x NPTF male branch tee

Code	Description
07080	1/4 nptf
07081	3/8 nptf
07082	1/2 nptf
07083	3/4 nptf
07084	1 nptf
07085	1-1/4 nptf
07086	1-1/2 nptf
07087	2 nptf

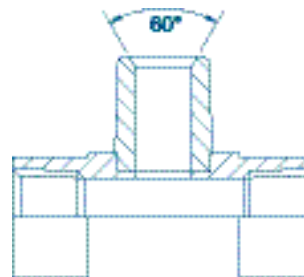

JIC swivel female x JIC swivel female x JIC male branch tee

Code	Description
03010	7/16 jic
03011	1/2 jic
03012	9/16 jic
03013	3/4 jic
03014	7/8 jic
03015	1-1/16 jic
03016	1-5/16 jic

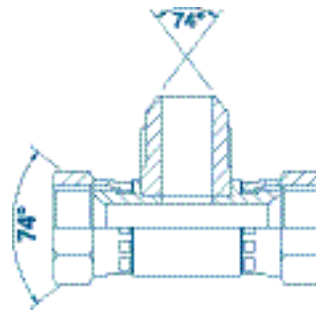

BSP swivel female tee

Code	Description
01975	1/8 bsp
01976	1/4 bsp
01977	3/8 bsp
01978	1/2 bsp
01979	5/8 bsp
01980	3/4 bsp
01981	1 bsp
01982	1-1/4 bsp
01983	1-1/2 bsp
01984	2 bsp

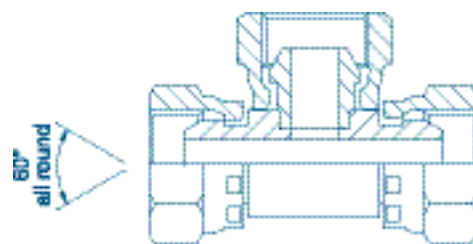

BSP swivel female tee REDUCING ON BRANCH

Code	Description
01988	3/8 bsp x 3/8 bsp x 1/4 bsp
01991	1/2 bsp x 1/2 bsp x 1/4 bsp
01989	1/2 bsp x 1/2 bsp x 3/8 bsp
01985	3/4 bsp x 3/4 bsp x 1/2 bsp
01987	1 bsp x 1 bsp x 1/2 bsp
01986	1 bsp x 1 bsp x 3/4 bsp
01994	1-1/4 bsp x 1-1/4 bsp x 3/4 bsp
01990	1-1/4 bsp x 1-1/4 bsp x 1 bsp

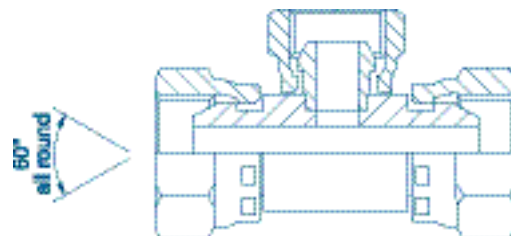

BSP swivel female tee ENLARGING ON BRANCH

Code	Description
01992	1/4 bsp x 1/4 bsp x 3/8 bsp

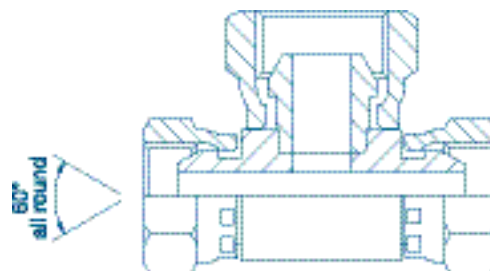

BSP fixed female tee

Code	Description
11975	1/8 bsp
11976	1/4 bsp
11977	3/8 bsp
11978	1/2 bsp
11979	5/8 bsp
11980	3/4 bsp
11981	1 bsp
11982	1-1/4 bsp
11985	1-1/2 bsp
11984	2 bsp

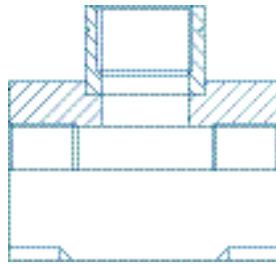

NPTF fixed female tee

Code	Description
07000	1/8 nptf
07001	1/4 nptf
07002	3/8 nptf
07003	1/2 nptf
07004	3/4 nptf
07005	1 nptf
07006	1-1/4 nptf
07007	1-1/2 nptf
07008	2 nptf

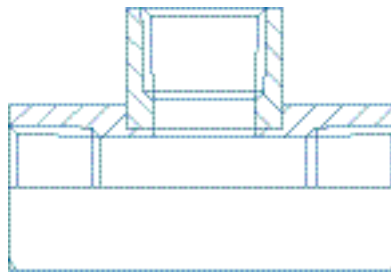

JIC swivel female tee

Code	Description
09650	7/16 jic
09651	1/2 jic
09652	9/16 jic
09653	3/4 jic
09654	7/8 jic
09655	1-1/16 jic
09658	1-3/16 jic
09656	1-5/16 jic
09657	1-5/8 jic
09647	1-7/8 jic
09648	2-1/2 jic

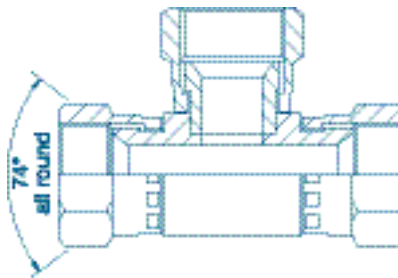

BSP male cross for bonded seal

Code	Description
03007	1/8 bsp
03000	1/4 bsp
03001	3/8 bsp
03002	1/2 bsp
03003	5/8 bsp
03004	3/4 bsp
03005	1 bsp
03006	1-1/4 bsp

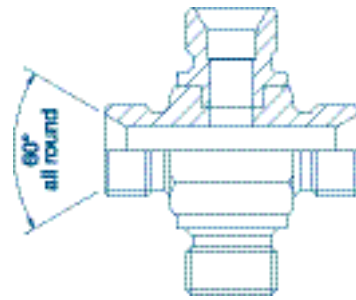

JIC male cross

Code	Description
03030	7/16 jic
03031	1/2 jic
03032	9/16 jic
03033	3/4 jic
03034	7/8 jic
03036	1-1/16 jic
03035	1-5/16 jic
03037	1-5/8 jic

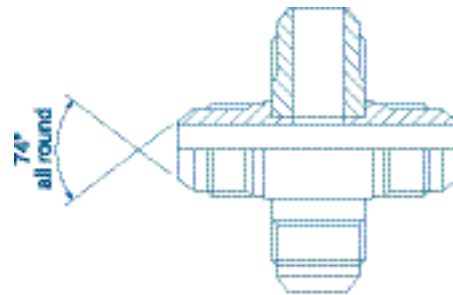

BSP swivel female cross

Code	Description
03019	1/8 bsp
03020	1/4 bsp
03021	3/8 bsp
03022	1/2 bsp
03025	5/8 bsp
03023	3/4 bsp
03024	1 bsp
03026	1-1/4 bsp
03027	1-1/2 bsp
03028	2 bsp

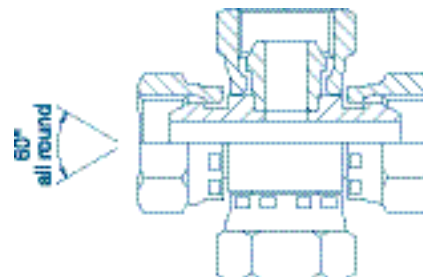

BSP fixed female cross

Code	Description
13023	1/8 bsp
13020	1/4 bsp
13021	3/8 bsp
13022	1/2 bsp
13024	3/4 bsp
13025	1 bsp
13026	1-1/4 bsp
13029	2-1/2 bsp

Other sizes in this range may be available on request.

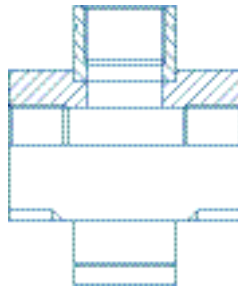

NPTF fixed female cross

Code	Description
37000	1/4 nptf
37001	3/8 nptf
37002	1/2 nptf
37003	3/4 nptf
37004	1 nptf
37006	1-1/2 nptf

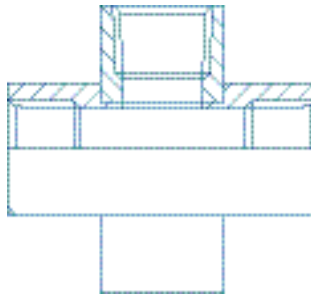

NPTF male cross

Code	Description
04030	1/4 nptf
04031	3/8 nptf
04032	1/2 nptf
04033	3/4 nptf

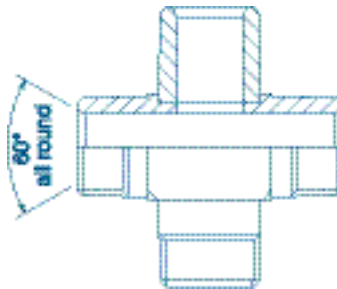

Contents Section 6

Male x Male Elbows

78	BSP male x BSP male 90° compact elbow
78	BSP male x BSP male 90° compact elbow for bonded seal
78	BSP male x BSPT male 90° compact elbow
79	BSP male x NPTF male 90° compact elbow
79	BSP male x JIC male 90° compact elbow
79	NPTF male x NPTF male 90° compact elbow
80	NPTF male x JIC male 90° compact elbow
80	NPTF male x JIC male extended 90° compact elbow
81	NPTF male x JIC male extended 90° compact elbow
81	NPTF male x JIC male extended 90° compact elbow
81	NPTF male x SAE male 45° external flare 90° compact elbow
82	JIC male x JIC male 90° compact elbow
82	BSPT male x JIC male 90° compact elbow
83	BSPT male x BSPT male 90° compact elbow

Male x Female Elbows

83	BSP male for bonded seal x BSP swivel female 90° compact elbow
83	BSP male cone seat x BSP swivel female 90° compact elbow
84	BSP male x JIC swivel female 90° compact elbow
84	BSPT male x BSP swivel female 90° compact elbow
84	NPTF male x NPTF fixed female 90° compact elbow
85	NPTF male x BSP swivel female 90° compact elbow
85	NPTF male x JIC swivel female 90° compact elbow
85	NPTF male x NPSM swivel female 90° compact elbow
86	JIC male x JIC swivel female 90° compact elbow
86	JIC male x BSP swivel female 90° compact elbow

Female x Female Elbows

86	BSP swivel female x BSP swivel female 90° compact elbow
87	BSP fixed female x BSP fixed female 90° compact elbow
87	NPTF fixed female x NPTF fixed female 90° compact elbow
87	JIC swivel female x JIC swivel female 90° compact elbow

45° Compact Elbows

88	BSP male x BSP swivel female 45° compact elbow
88	NPTF male x JIC male 45° compact elbow
88	JIC male x JIC swivel female 45° compact elbow

BSP male x BSP male 90° compact elbow

Code	Description
03051	1/4 bsp x 1/4 bsp
03052	1/4 bsp x 3/8 bsp
03053	3/8 bsp x 3/8 bsp
03061	3/8 bsp x 1/2 bsp
03054	1/2 bsp x 1/2 bsp
03062	1/2 bsp x 3/4 bsp
03055	5/8 bsp x 5/8 bsp
03056	3/4 bsp x 3/4 bsp
03057	1 bsp x 1 bsp
03059	1-1/2 bsp x 1-1/2 bsp
03060	2 bsp x 2 bsp

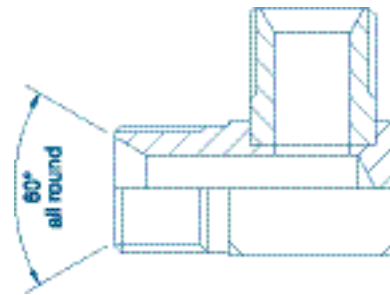

BSP male x BSP male 90° compact elbow for bonded seal

Code	Description
04006	1/8 bsp x 1/8 bsp
04009	1/4 bsp x 1/8 bsp
04000	1/4 bsp x 1/4 bsp
04001	3/8 bsp x 3/8 bsp
04010	1/2 bsp x 3/8 bsp
04002	1/2 bsp x 1/2 bsp
03099	1/2 bsp x 3/4 bsp
04007	5/8 bsp x 5/8 bsp
04003	3/4 bsp x 3/4 bsp
04008	1 bsp x 3/4 bsp
04004	1 bsp x 1 bsp
04005	1-1/4 bsp x 1-1/4 bsp

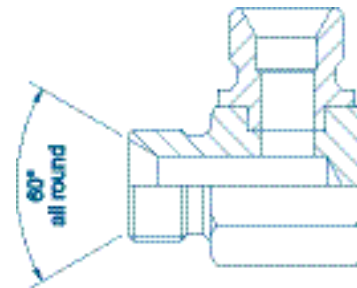

BSP male x BSPT male 90° compact elbow

Code	Description
03069	1/8 bsp x 1/8 bspt
03073	1/4 bsp x 1/8 bspt
03070	1/4 bsp x 1/4 bspt
03079	1/4 bsp x 3/8 bspt
03071	3/8 bsp x 3/8 bspt
03077	1/2 bsp x 3/8 bspt
03072	1/2 bsp x 1/2 bspt
03074	3/4 bsp x 3/4 bspt
03078	3/4 bsp x 1 bspt
03067	1 bsp x 3/4 bspt
03075	1 bsp x 1 bspt
03082	1-1/4 bsp x 1-1/4 bspt
03068	1-1/2 bsp x 1-1/2 bspt
03076	2 bsp x 2 bspt

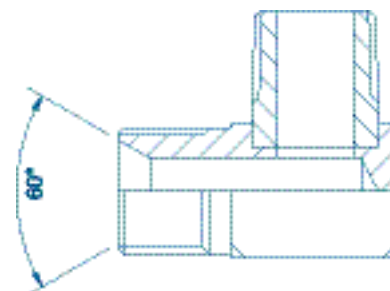

BSP male x NPTF male 90° compact elbow

Code	Description
13076	1/8 bsp x 1/8 nptf
13073	1/8 bsp x 1/4 nptf
13070	1/4 bsp x 1/4 nptf
13071	3/8 bsp x 3/8 nptf
13072	1/2 bsp x 1/2 nptf
13074	3/4 bsp x 3/4 nptf
13077	1 bsp x 3/4 nptf
13075	1 bsp x 1 nptf
13078	1-1/2 bsp x 1-1/2 nptf
13069	2 bsp x 2 nptf

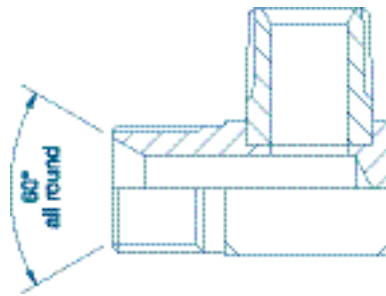

BSP male x JIC male 90° compact elbow

Code	Description
07070	1/4 bsp x 7/16 jic
07071	1/4 bsp x 1/2 jic
07072	1/4 bsp x 9/16 jic
07073	3/8 bsp x 9/16 jic
07077	3/8 bsp x 3/4 jic
07074	1/2 bsp x 3/4 jic
07079	1/2 bsp x 7/8 jic
07069-08B	1/2 bsp x 1-1/16 jic
07078	3/4 bsp x 7/8 jic
07075	3/4 bsp x 1-1/16 jic
07069	1 bsp x 1-1/16 jic
07076	1 bsp x 1-5/16 jic
07068-16B	1 bsp x 1-5/8 jic
07067-16B	1 bsp x 1-7/8 jic
07068	1-1/4 bsp x 1-5/8 jic
07067	1-1/2 bsp x 1-7/8 jic

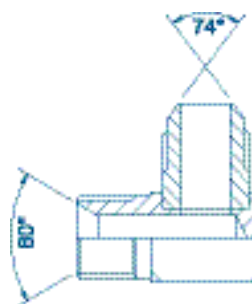

NPTF male x NPTF male 90° compact elbow

Code	Description
08000	1/8 nptf x 1/8 nptf
08001	1/4 nptf x 1/4 nptf
08009	1/4 nptf x 3/8 nptf
07097	1/4 nptf x 1/2 nptf
08002	3/8 nptf x 3/8 nptf
07098	3/8 nptf x 1/2 nptf
07099	3/8 nptf x 3/4 nptf
08003	1/2 nptf x 1/2 nptf
08004	3/4 nptf x 3/4 nptf
08005	1 nptf x 1 nptf
08006	1-1/4 nptf x 1-1/4 nptf
08007	1-1/2 nptf x 1-1/2 nptf
08008	2 nptf x 2 nptf

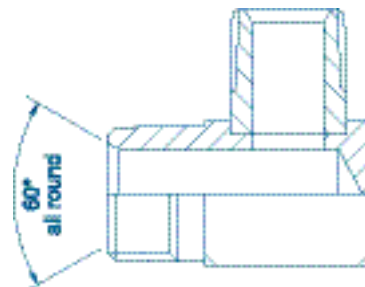

NPTF male x JIC male 90° compact elbow

Code	Description
04086	1/8 nptf x 5/16 jic
04067	1/8 nptf x 3/8 jic
04050	1/8 nptf x 7/16 jic
04051	1/8 nptf x 1/2 jic
04052	1/8 nptf x 9/16 jic
04053	1/4 nptf x 7/16 jic
04054	1/4 nptf x 1/2 jic
04055	1/4 nptf x 9/16 jic
04056	1/4 nptf x 3/4 jic
04087	3/8 nptf x 3/8 jic
04057	3/8 nptf x 7/16 jic
04058	3/8 nptf x 1/2 jic
04059	3/8 nptf x 9/16 jic
04060	3/8 nptf x 3/4 jic
04061	3/8 nptf x 7/8 jic
04048	3/8 nptf x 1-1/16 jic
04069	3/8 nptf x 1-5/16 jic
04092	1/2 nptf x 3/8 jic
04062	1/2 nptf x 7/16 jic
04063	1/2 nptf x 1/2 jic
04064	1/2 nptf x 9/16 jic
04065	1/2 nptf x 3/4 jic
04066	1/2 nptf x 7/8 jic
04082	1/2 nptf x 1-1/16 jic
04068	1/2 nptf x 1-5/16 jic
04070	3/4 nptf x 9/16 jic
04071	3/4 nptf x 3/4 jic
04072	3/4 nptf x 7/8 jic
04073	3/4 nptf x 1-1/16 jic
04075	3/4 nptf x 1-5/16 jic
04090	3/4 nptf x 1-5/8 jic

Code	Description
04085	1 nptf x 3/4 jic
04089	1 nptf x 7/8 jic
04074	1 nptf x 1-1/16 jic
04076	1 nptf x 1-5/16 jic
04077	1 nptf x 1-5/8 jic
04078	1-1/4 nptf x 1-5/16 jic
04079	1-1/4 nptf x 1-5/8 jic
04083	1-1/4 nptf x 1-7/8 jic
04091	1-1/2 nptf x 1-5/16 jic
04084	1-1/2 nptf x 1-5/8 jic
04080	1-1/2 nptf x 1-7/8 jic
04088	1-1/2 nptf x 2-1/2 jic
04081	2 nptf x 2-1/2 jic

If forged required, please suffix code number with FD.
ie: 04075FD. Prices remain the same.

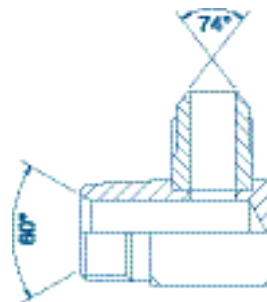

NPTF male x JIC male extended 90° compact elbow

Code	Description	A
14053	1/4 nptf x 7/16 jic	1.59"
14055	1/4 nptf x 9/16 jic	1.66"
14059	3/8 nptf x 9/16 jic	1.81"
14060	3/8 nptf x 3/4 jic	1.81"
14065	1/2 nptf x 3/4 jic	2.16"
14066	1/2 nptf x 7/8 jic	2.22"
14073	3/4 nptf x 1-1/16 jic	2.47"
14076	1 nptf x 1-5/16 jic	3.06"

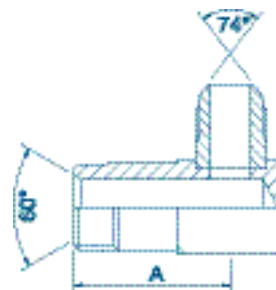

NPTF male x JIC male extended 90° compact elbow

Code	Description	A
24053	1/4 nptf x 7/16 jic	1.99"
24055	1/4 nptf x 9/16 jic	2.06"
24059	3/8 nptf x 9/16 jic	2.41"
24060	3/8 nptf x 3/4 jic	2.50"
24065	1/2 nptf x 3/4 jic	3.00"
24066	1/2 nptf x 7/8 jic	3.00"
24082	1/2 nptf x 1-1/16 jic	3.00"
24073	3/4 nptf x 1-1/16 jic	3.34"
24076	1 nptf x 1-5/16 jic	4.19"
24079	1-1/4 nptf x 1-5/8 jic	4.84"

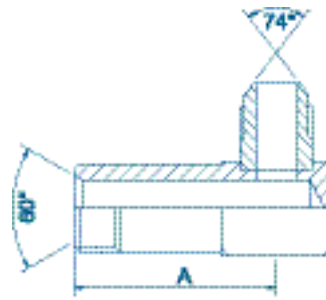

NPTF male x JIC male extended 90° compact elbow

Code	Description	A
34053	1/4 nptf x 7/16 jic	2.99"
34055	1/4 nptf x 9/16 jic	3.06"
34059	3/8 nptf x 9/16 jic	3.75"
34060	3/8 nptf x 3/4 jic	3.75"
34065	1/2 nptf x 3/4 jic	4.50"
34066	1/2 nptf x 7/8 jic	4.50"
34073	3/4 nptf x 1-1/16 jic	5.03"
34076	1 nptf x 1-5/16 jic	6.34"

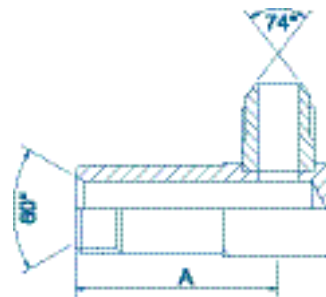

NPTF male x SAE male 45° external flare 90° compact elbow

Code	Description
07020	1/8 nptf x 7/16 sae
07021	1/8 nptf x 1/2 sae
07022	1/4 nptf x 7/16 sae
07023	1/4 nptf x 1/2 sae
07024	1/4 nptf x 5/8 sae
07025	1/4 nptf x 3/4 sae
07026	3/8 nptf x 7/16 sae
07027	3/8 nptf x 1/2 sae
07028	3/8 nptf x 5/8 sae
07029	3/8 nptf x 3/4 sae
07030	3/8 nptf x 7/8 sae
07031	1/2 nptf x 5/8 sae
07032	1/2 nptf x 3/4 sae
07033	1/2 nptf x 7/8 sae
07037	3/4 nptf x 7/8 sae
07038	3/4 nptf x 1-1/16 sae

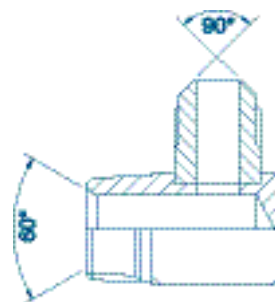

JIC male x JIC male 90° compact elbow

Code	Description
03085	7/16 jic x 7/16 jic
03086	1/2 jic x 1/2 jic
03087	9/16 jic x 9/16 jic
03095	9/16 jic x 3/4 jic
03097	9/16 jic x 1-1/16 jic
03088	3/4 jic x 3/4 jic
03096	3/4 jic x 7/8 jic
03089	7/8 jic x 7/8 jic
03090	1-1/16 jic x 1-1/16 jic
03091	1-3/16 jic x 1-3/16 jic
03092	1-5/16 jic x 1-5/16 jic
03094	1-5/8 jic x 1-5/8 jic
03093	1-7/8 jic x 1-7/8 jic

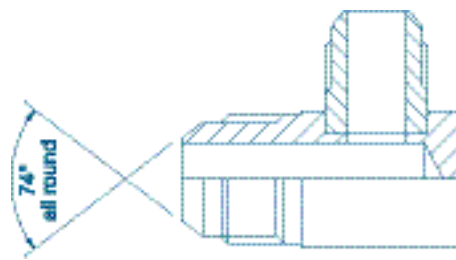

BSPT male x JIC male 90° compact elbow

Code	Description
08550	1/8 bspt x 7/16 jic
08551	1/8 bspt x 1/2 jic
08552	1/8 bspt x 9/16 jic
08553	1/4 bspt x 7/16 jic
08554	1/4 bspt x 1/2 jic
08555	1/4 bspt x 9/16 jic
08556	1/4 bspt x 3/4 jic
08557	3/8 bspt x 7/16 jic
08558	3/8 bspt x 1/2 jic
08559	3/8 bspt x 9/16 jic
08560	3/8 bspt x 3/4 jic
08561	3/8 bspt x 7/8 jic
08562	1/2 bspt x 7/16 jic
08563	1/2 bspt x 1/2 jic
08564	1/2 bspt x 9/16 jic
08565	1/2 bspt x 3/4 jic
08566	1/2 bspt x 7/8 jic
08567	1/2 bspt x 1-1/16 jic
08584	1/2 bspt x 1-5/16 jic
08568	3/4 bspt x 9/16 jic
08569	3/4 bspt x 3/4 jic
08570	3/4 bspt x 7/8 jic
08571	3/4 bspt x 1-1/16 jic
08572	3/4 bspt x 1-5/16 jic

Code	Description
08573	1 bspt x 3/4 jic
08585	1 bspt x 7/8 jic
08574	1 bspt x 1-1/16 jic
08575	1 bspt x 1-5/16 jic
08576	1 bspt x 1-5/8 jic
08577	1-1/4 bspt x 1-5/16 jic
08578	1-1/4 bspt x 1-5/8 jic
08579	1-1/4 bspt x 1-7/8 jic
08580	1-1/2 bspt x 1-5/8 jic
08581	1-1/2 bspt x 1-7/8 jic
08582	2 bspt x 2-1/2 jic

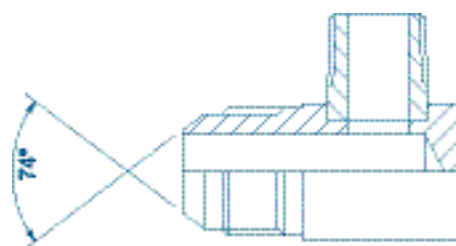

BSPT male x BSPT male 90° compact elbow

Code	Description
83000	1/4 bspt x 1/4 bspt
83001	3/8 bspt x 3/8 bspt
83002	1/2 bspt x 1/2 bspt
83003	3/4 bspt x 3/4 bspt
83004	1 bspt x 1 bspt
83005	1-1/4 bspt x 1-1/4 bspt

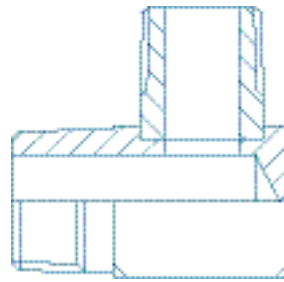

BSP male for bonded seal x BSP swivel female 90° compact elbow

Code	Description
04012	1/8 bsp x 1/8 bsp
04014	1/4 bsp x 1/4 bsp
04013	3/8 bsp x 1/4 bsp
04015	3/8 bsp x 3/8 bsp
04021	1/2 bsp x 3/8 bsp
04016	1/2 bsp x 1/2 bsp
04024	1/2 bsp x 5/8 bsp
04011	1/2 bsp x 3/4 bsp
04020	5/8 bsp x 5/8 bsp
04022	3/4 bsp x 1/2 bsp
04017	3/4 bsp x 3/4 bsp
04018	1 bsp x 1 bsp

Code	Description
04019	1-1/4 bsp x 1-1/4 bsp
04025	1-1/2 bsp x 1-1/2 bsp
04023	2 bsp x 2 bsp

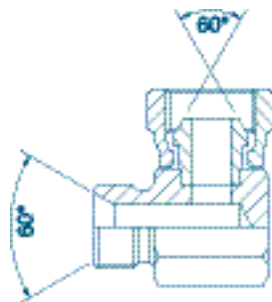

BSP male cone seat x BSP swivel female 90° compact elbow

Code	Description
05013	1/4 bsp x 1/8 bsp
05000	1/4 bsp x 1/4 bsp
05006	1/4 bsp x 3/8 bsp
05014	3/8 bsp x 1/4 bsp
05001	3/8 bsp x 3/8 bsp
05011	3/8 bsp x 1/2 bsp
05019	3/8 bsp x 3/4 bsp
05015	1/2 bsp x 3/8 bsp
05002	1/2 bsp x 1/2 bsp
05012	1/2 bsp x 3/4 bsp
05017	1/2 bsp x 1 bsp
05004	3/4 bsp x 3/4 bsp
05010	3/4 bsp x 1 bsp
05009	1 bsp x 3/4 bsp
05005	1 bsp x 1 bsp
05007	1-1/2 bsp x 1-1/2 bsp
05008	2 bsp x 2 bsp

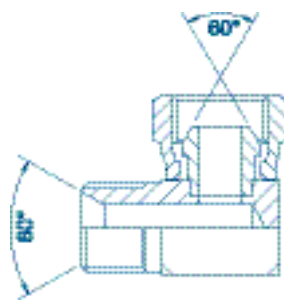

BSP male x JIC swivel female 90° compact elbow

Code	Description
19504	1/4 bsp x 7/16 jic
19514	1/4 bsp x 1/2 jic
19511	1/4 bsp x 9/16 jic
19505	3/8 bsp x 9/16 jic
19507	3/8 bsp x 3/4 jic
19508	1/2 bsp x 9/16 jic
19509	1/2 bsp x 3/4 jic
19506	1/2 bsp x 7/8 jic
19513	5/8 bsp x 7/8 jic
19510	3/4 bsp x 1-1/16 jic
19515	3/4 bsp x 1-5/16 jic
19512	1 bsp x 7/8 jic
19516	1 bsp x 1-5/16 jic

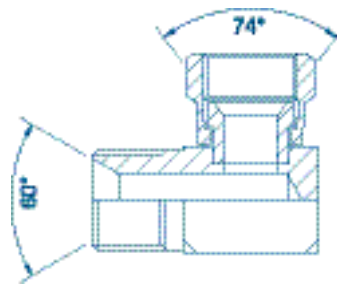

BSPT male x BSP swivel female 90° compact elbow

Code	Description
09410	1/8 bspt x 1/8 bsp
09405	1/4 bspt x 1/4 bsp
09406	3/8 bspt x 3/8 bsp
09407	1/2 bspt x 1/2 bsp
09411	3/4 bspt x 1/2 bsp
09408	3/4 bspt x 3/4 bsp
09409	1 bspt x 1 bsp
09412	1-1/2 bspt x 1-1/2 bsp

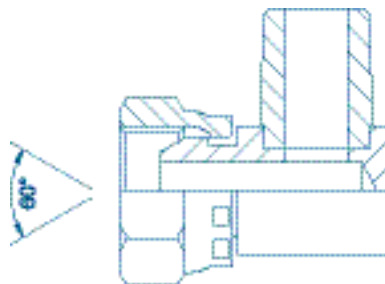

NPTF male x NPTF fixed female 90° compact elbow

Code	Description
07050	1/8 nptf x 1/8 nptf
07044	1/4 nptf x 1/8 nptf
07051	1/4 nptf x 1/4 nptf
07047	1/4 nptf x 3/8 nptf
07048	3/8 nptf x 1/4 nptf
07052	3/8 nptf x 3/8 nptf
07043	3/8 nptf x 1/2 nptf
07046	1/2 nptf x 1/4 nptf
07049	1/2 nptf x 3/8 nptf
07053	1/2 nptf x 1/2 nptf
07045	3/4 nptf x 3/8 nptf
07054	3/4 nptf x 3/4 nptf
07055	1 nptf x 1 nptf
07056	1-1/4 nptf x 1-1/4 nptf
07057	1-1/2 nptf x 1-1/2 nptf
07058	2 nptf x 2 nptf

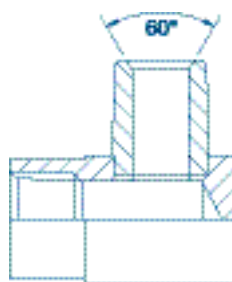

Now available as forged. See Section 10.

NPTF male x BSP swivel female 90° compact elbow

Code	Description
09397	1/8 nptf x 1/8 bsp
09393	1/8 nptf x 1/4 bsp
09400	1/4 nptf x 1/4 bsp
09401	3/8 nptf x 3/8 bsp
09402	1/2 nptf x 1/2 bsp
09403	3/4 nptf x 3/4 bsp
09404	1 nptf x 1 bsp
09398	1-1/4 nptf x 1-1/4 bsp
09399	1-1/2 nptf x 1-1/2 bsp

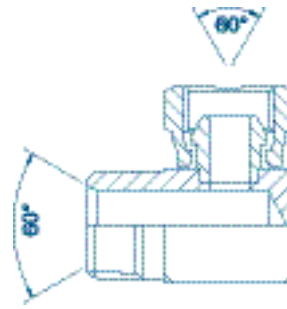

NPTF male x JIC swivel female 90° compact elbow

Code	Description
99000	1/4 nptf x 7/16 jic
99006	1/4 nptf x 9/16 jic
99001	3/8 nptf x 9/16 jic
99002	1/2 nptf x 3/4 jic
99003	3/4 nptf x 1-1/16 jic
99004	1 nptf x 1-5/16 jic
99005	1-1/4 nptf x 1-5/8 jic

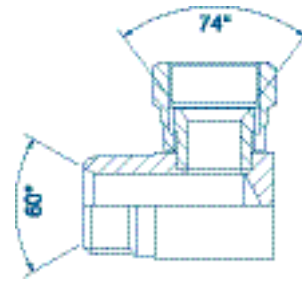

NPTF male x NPSM swivel female 90° compact elbow

Code	Description
19448	1/8 nptf x 1/8 npsm
19449	1/4 nptf x 1/8 npsm
19450	1/4 nptf x 1/4 npsm
19452	1/4 nptf x 3/8 npsm
19451	3/8 nptf x 1/4 npsm
19453	3/8 nptf x 3/8 npsm
19455	3/8 nptf x 1/2 npsm
19454	1/2 nptf x 3/8 npsm
19456	1/2 nptf x 1/2 npsm
19459	1/2 nptf x 3/4 npsm
19457	3/4 nptf x 1/2 npsm
19458	3/4 nptf x 3/4 npsm
19460	1 nptf x 3/4 npsm
19461	2 nptf x 2 npsm

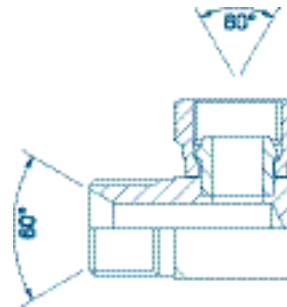

JIC male x JIC swivel female 90° compact elbow

Code	Description
05050	7/16 jic x 7/16 jic
05051	1/2 jic x 1/2 jic
05052	9/16 jic x 9/16 jic
05053	3/4 jic x 3/4 jic
05062	3/4 jic x 7/8 jic
05061	7/8 jic x 3/4 jic
05054	7/8 jic x 7/8 jic
05055	1-1/16 jic x 1-1/16 jic
05057	1-3/16 jic x 1-3/16 jic
05056	1-5/16 jic x 1-5/16 jic
05058	1-5/8 jic x 1-5/8 jic
05059	1-7/8 jic x 1-7/8 jic
05063	2-1/2 jic x 2-1/2 jic

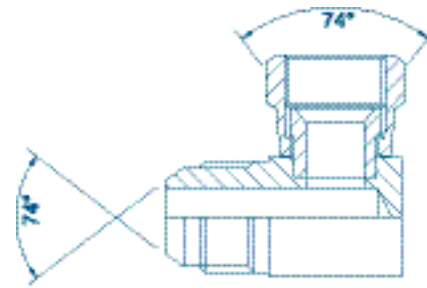

JIC male x BSP swivel female 90° compact elbow

Code	Description
09612	7/16 jic x 1/4 bsp
09605	9/16 jic x 3/8 bsp
09608	3/4 jic x 3/8 bsp
09606	3/4 jic x 1/2 bsp
09613	7/8 jic x 1/2 bsp
09607	1-1/16 jic x 3/4 bsp
09609	1-5/16 jic x 1 bsp
09611	1-5/8 jic x 1-1/4 bsp
09610	1-7/8 jic x 1-1/2 bsp

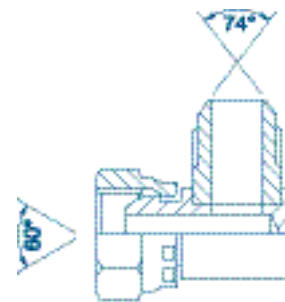

BSP swivel female x BSP swivel female 90° compact elbow

Code	Description
05025	1/8 bsp x 1/8 bsp
05036	1/8 bsp x 1/4 bsp
05026	1/4 bsp x 1/4 bsp
05039	1/4 bsp x 3/8 bsp
05037	1/4 bsp x 1/2 bsp
05027	3/8 bsp x 3/8 bsp
05035	3/8 bsp x 1/2 bsp
05028	1/2 bsp x 1/2 bsp
05040	1/2 bsp x 3/4 bsp
05029	5/8 bsp x 5/8 bsp
05030	3/4 bsp x 3/4 bsp
05038	3/4 bsp x 1 bsp
05031	1 bsp x 1 bsp
05032	1-1/4 bsp x 1-1/4 bsp
05033	1-1/2 bsp x 1-1/2 bsp
05034	2 bsp x 2 bsp

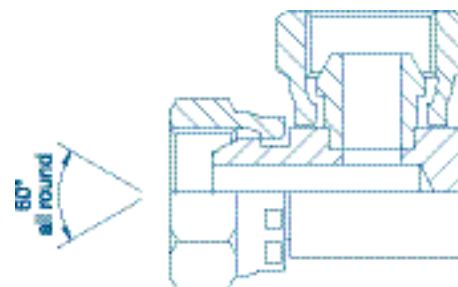

BSP fixed female x BSP fixed female 90° compact elbow

Code	Description
15026	1/4 bsp x 1/4 bsp
15027	3/8 bsp x 3/8 bsp
15028	1/2 bsp x 1/2 bsp
15030	3/4 bsp x 3/4 bsp
15031	1 bsp x 1 bsp
15032	1-1/4 bsp x 1-1/4 bsp
15033	1-1/2 bsp x 1-1/2 bsp
15034	2 bsp x 2 bsp

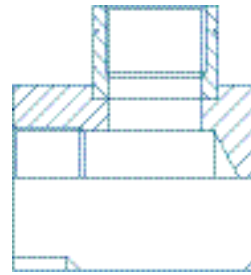

NPTF fixed female x NPTF fixed female 90° compact elbow

Code	Description
06082	1/8 nptf x 1/8 nptf
06075	1/4 nptf x 1/4 nptf
06084	1/4 nptf x 3/8 nptf
06074	1/4 nptf x 1/2 nptf
06076	3/8 nptf x 3/8 nptf
06085	3/8 nptf x 1/2 nptf
06073	3/8 nptf x 3/4 nptf
06077	1/2 nptf x 1/2 nptf
06078	3/4 nptf x 3/4 nptf
06079	1 nptf x 1 nptf
06080	1-1/4 nptf x 1-1/4 nptf
06081	1-1/2 nptf x 1-1/2 nptf
06083	2 nptf x 2 nptf

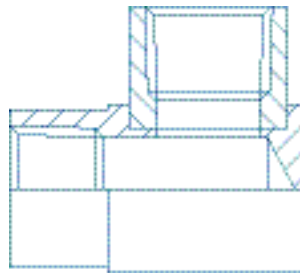

JIC swivel female x JIC swivel female 90° compact elbow

Code	Description
05075	7/16 jic x 7/16 jic
05076	1/2 jic x 1/2 jic
05077	9/16 jic x 9/16 jic
05078	3/4 jic x 3/4 jic
05079	7/8 jic x 7/8 jic
05080	1-1/16 jic x 1-1/16 jic
05082	1-3/16 jic x 1-3/16 jic
05081	1-5/16 jic x 1-5/16 jic
05083	1-5/8 jic x 1-5/8 jic
05084	1-7/8 jic x 1-7/8 jic

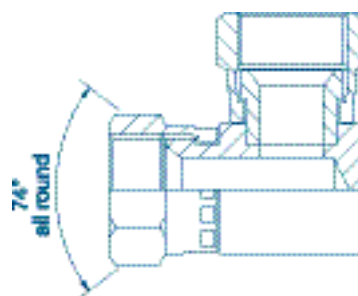

BSP male cone seal x BSP swivel female 45° compact elbow

Code	Description
05000/45	1/4 bsp x 1/4 bsp
05001/45	3/8 bsp x 3/8 bsp
05002/45	1/2 bsp x 1/2 bsp
05003/45	5/8 bsp x 5/8 bsp
05004/45	3/4 bsp x 3/4 bsp
05005/45	1 bsp x 1 bsp

When stocks are depleted then only forged will be available.

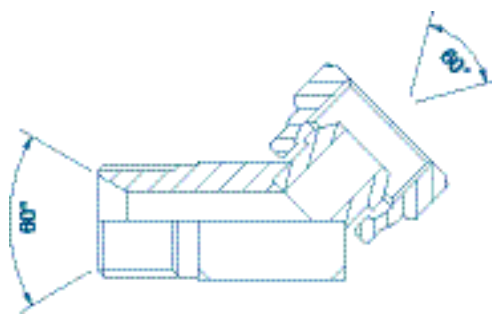

NPTF male x JIC male 45° compact elbow

Code	Description
04050/45	1/8 nptf x 7/16 jic
04053/45	1/4 nptf x 7/16 jic
04059/45	3/8 nptf x 9/16 jic
04060/45	3/8 nptf x 3/4 jic
04065/45	1/2 nptf x 3/4 jic
04073/45	3/4 nptf x 1-1/16 jic
04075/45	3/4 nptf x 1-5/16 jic
04076/45	1 nptf x 1-5/16 jic

When stocks are depleted then only forged will be available.

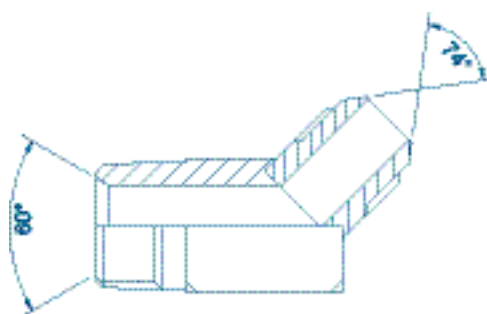

JIC male x JIC swivel female 45° compact elbow

Code	Description
05050/45	7/16 jic x 7/16 jic
05052/45	9/16 jic x 9/16 jic
05053/45	3/4 jic x 3/4 jic
05055/45	1-1/16 jic x 1-1/16 jic
05056/45	1-5/16 jic x 1-5/16 jic
05059/45	1-7/8 jic x 1-7/8 jic

When stocks are depleted then only forged will be available.

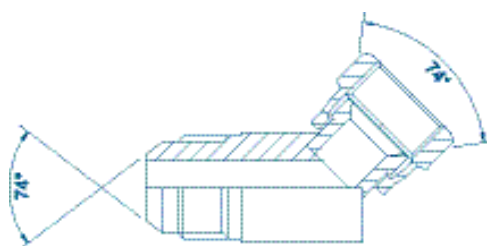

Contents Section 7

Plugs

90	BSP solid plug
90	BSP 60° coned plug
90	BSP coned plug to DIN 3852 Form A
91	BSP socket headed plug for bonded seal
91	BSP socket headed plug WITH 3869 SEAL
91	BSPT solid plug
92	NPTF solid plug
92	NPTF hexagon socket plug
92	METRIC solid plug 1.5mm pitch
93	METRIC solid plug 1.0mm pitch
93	METRIC socket headed plug for bonded seal
93	METRIC socket headed plug WITH 3869 SEAL
94	JIC solid plug
94	SAE plug 45° cone external flare
94	SAE O'ring boss male solid plug
95	SAE O'ring boss male solid plug WITH O'RING
95	SAE O'ring boss male socket headed plug WITH O'RING

Caps

95	BSP swivel blanking cap
96	METRIC swivel blanking cap 1.5mm pitch
96	JIC swivel blanking cap
96	NPTF fixed female cap
97	SAE fixed female cap

Crimp Nuts

97	BSP crimp nut
97	METRIC crimp nut 1.5mm pitch
98	JIC crimp nut
98	NPSM crimp nut

BSP solid plug

Code	Description
09025	1/8 bsp
09026	1/4 bsp
09027	3/8 bsp
09028	1/2 bsp
09029	5/8 bsp
09030	3/4 bsp
09031	1 bsp
09032	1-1/4 bsp
09033	1-1/2 bsp
09034	2 bsp
09037	3 bsp

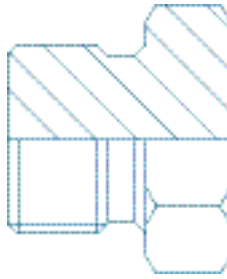

BSP 60° coned plug

Code	Description
09050	1/8 bsp
09051	1/4 bsp
09052	3/8 bsp
09053	1/2 bsp
09054	5/8 bsp
09055	3/4 bsp
09056	1 bsp
09057	1-1/4 bsp
09058	1-1/2 bsp
09059	2 bsp
09060	2-1/2 bsp
09061	3 bsp
09062	4 bsp

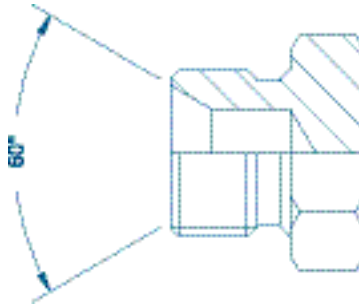

BSP coned plug to DIN 3852 Form A

Code	Description
69000	1/8 bsp
69001	1/4 bsp
69002	3/8 bsp
69003	1/2 bsp
69005	3/4 bsp
69006	1 bsp
69007	1-1/4 bsp
69008	1-1/2 bsp
69009	2 bsp

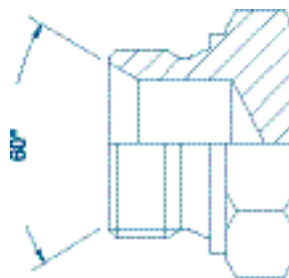

BSP socket headed plug for bonded seal

Code	Description
09025-02-SPG	1/8 bsp
09026-04-SPG	1/4 bsp
09027-06-SPG	3/8 bsp
09028-08-SPG	1/2 bsp
09030-12-SPG	3/4 bsp

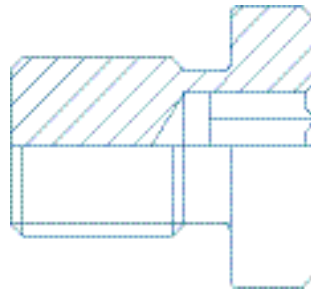

BSP socket headed plug WITH 3869 SEAL

Code	Description
3869-02-SPG	1/8 bsp
3869-04-SPG	1/4 bsp
3869-06-SPG	3/8 bsp
3869-08-SPG	1/2 bsp
3869-12-SPG	3/4 bsp
3869-16-SPG	1 bsp

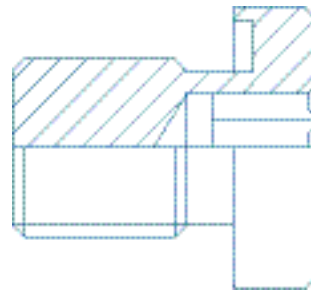

BSPT solid plug

Code	Description
09075	1/8 bspt
09076	1/4 bspt
09077	3/8 bspt
09078	1/2 bspt
09079	5/8 bspt
09080	3/4 bspt
09081	1 bspt
09082	1-1/4 bspt
09083	1-1/2 bspt
09084	2 bspt
09085	2-1/2 bspt
09086	3 bspt

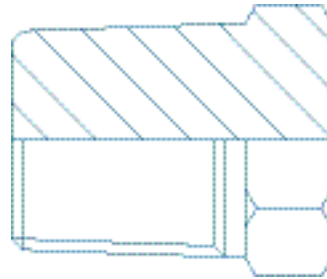

NPTF solid plug

Code	Description
09100	1/8 nptf
09101	1/4 nptf
09102	3/8 nptf
09103	1/2 nptf
09105	3/4 nptf
09106	1 nptf
09107	1-1/4 nptf
09108	1-1/2 nptf
09109	2 nptf
09110	2-1/2 nptf
09111	3 nptf
09113	3-1/2 nptf
09112	4 nptf

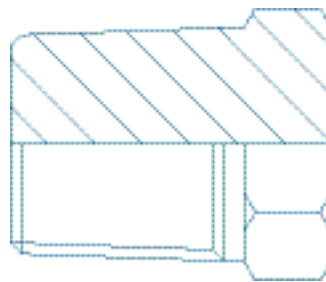

NPTF hexagon socket plugs

Code	Description
09100/HD	1/8 nptf
09101/HD	1/4 nptf
09102/HD	3/8 nptf
09103/HD	1/2 nptf
09105/HD	3/4 nptf
09106/HD	1 nptf

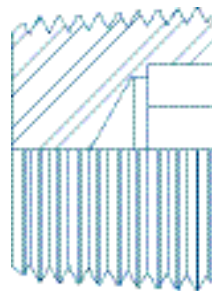

METRIC solid plug 1.5mm pitch

Code	Description
09171	10mm
09172	12mm
09173	14mm
09170	16mm
09174	18mm
09175	20mm
09176	22mm
09178	24mm
09177	26mm



METRIC solid plug 1.0mm pitch

Code	Description
09169	8mm
09179	10mm
09168	12mm



METRIC socket headed plug 1.5mm pitch for bonded seal

Code	Description
09179-M10-SPG	10 mm by 1 mm
09173-M14-SPG	14 mm
09170-M16-SPG	16 mm
09176-M22-SPG	22 mm

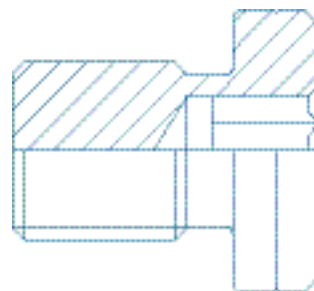

METRIC socket headed plug 1.5mm pitch WITH 3869 SEAL

Code	Description
3869-M10-SPG	10 mm by 1 mm
3869-M14-SPG	14 mm
3869-M16-SPG	16 mm
3869-M18-SPG	18 mm
3869-M22-SPG	22 mm
3869-M26-SPG	26 mm
3869-M27-SPG	27 mm by 2 mm

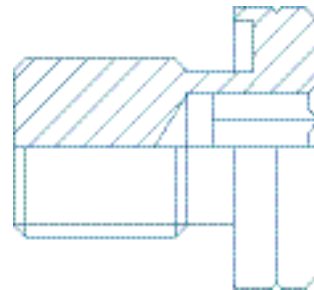

JIC solid plug

Code	Description
09120	5/16 jic
09121	7/16 jic
09122	1/2 jic
09123	9/16 jic
09124	3/4 jic
09125	7/8 jic
09126	1-1/16 jic
09127	1-3/16 jic
09130	1-5/16 jic
09128	1-5/8 jic
09129	1-7/8 jic
09131	2-1/2 jic
09132	3 jic

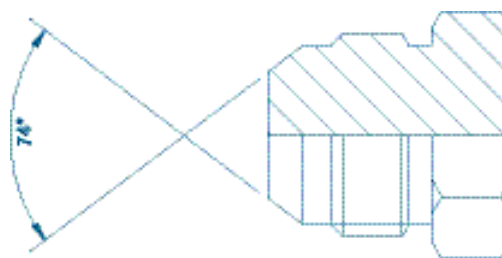

SAE plug 45° cone external flare

Code	Description
09090	5/8 sae

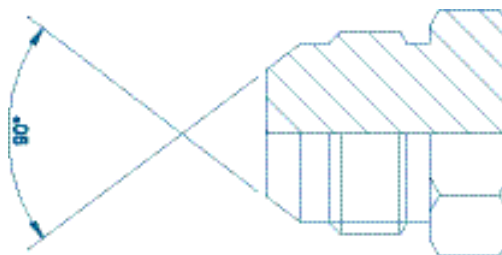

SAE O'ring boss male solid plug

Code	Description
09162	5/16 sorb
09149	3/8 sorb
09150	7/16 sorb
09151	1/2 sorb
09152	9/16 sorb
09161	5/8 sorb
09153	3/4 sorb
09154	7/8 sorb
09155	1-1/16 sorb
09156	1-3/16 sorb
09157	1-5/16 sorb
09158	1-5/8 sorb
09159	1-7/8 sorb
09160	2-1/2 sorb

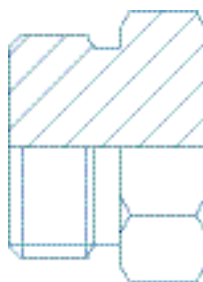

SAE O'ring boss male solid plug WITH O'RING

Code	Description
19162	5/16 sorb
19150	7/16 sorb
19151	1/2 sorb
19152	9/16 sorb
19161	5/8 sorb
19153	3/4 sorb
19154	7/8 sorb
19155	1-1/16 sorb
19156	1-3/16 sorb
19157	1-5/16 sorb
19158	1-5/8 sorb
19159	1-7/8 sorb
19160	2-1/2 sorb



SAE O'ring boss male socket headed plug WITH O'RING

Code	Description
7238-04	7/16 sorb
7238-05	1/2 sorb
7238-06	9/16 sorb
7238-08	3/4 sorb
7238-10	7/8 sorb
7238-12	1-1/16 sorb
7238-14	1-3/16 sorb
7238-16	1-5/16 sorb

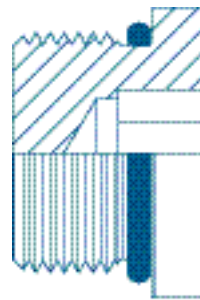

BSP swivel blanking cap

Code	Description
09180	1/8 bsp
09181	1/4 bsp
09182	3/8 bsp
09183	1/2 bsp
09184	5/8 bsp
09185	3/4 bsp
09186	1 bsp
09187	1-1/4 bsp
09188	1-1/2 bsp
09189	2 bsp

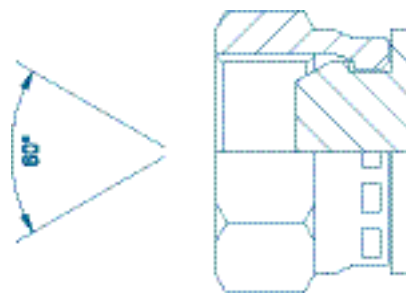

METRIC swivel blanking cap 1.5mm pitch

Code	Description
09660	12mm
09661	14mm
09662	16mm
09663	18mm
09664	20mm
09665	22mm
09666	24mm

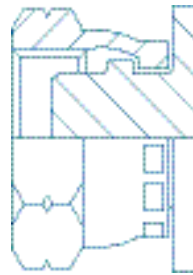

JIC swivel blanking cap

Code	Description
09200	7/16 jic
09201	1/2 jic
09202	9/16 jic
09203	3/4 jic
09204	7/8 jic
09205	1-1/16 jic
09209	1-3/16 jic
09206	1-5/16 jic
09207	1-5/8 jic
09208	1-7/8 jic
09210	2-1/2 jic

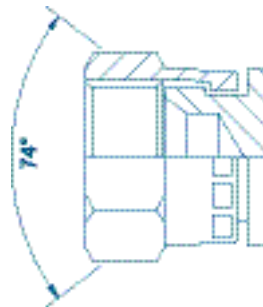

NPTF fixed female cap

Code	Description
09680	3/8 nptf
09681	1/2 nptf

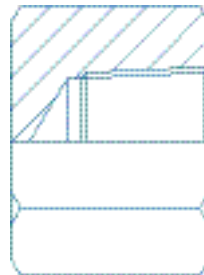

SAE fixed female cap

Code	Description
09820	5/8 sae



BSP crimp nut

Code	Description
08020	1/8 bsp
08021	1/4 bsp
08022	3/8 bsp
08023	1/2 bsp
08024	5/8 bsp
08025	3/4 bsp
08026	1 bsp
08027	1-1/4 bsp
08028	1-1/2 bsp
08029	2 bsp

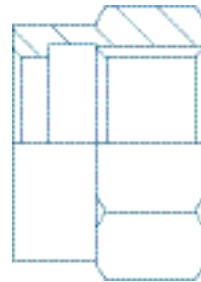

Availability of Crimp Nuts subject to stock levels being surplus to our requirements.

METRIC crimp nut 1.5mm pitch

Code	Description
08049	10mm
08050	12mm
08051	14mm
08052	16mm
08053	18mm
08054	20mm
08055	22mm
08056	24mm
08057	26mm
08058	30mm
08059	36mm

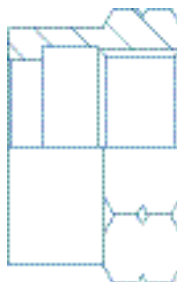

Availability of Crimp Nuts subject to stock levels being surplus to our requirements.

JIC crimp nut

Code	Description
08075	7/16 jic
08076	1/2 jic
08077	9/16 jic
08078	3/4 jic
08079	7/8 jic
08080	1-1/16 jic
08084	1-3/16 jic
08081	1-5/16 jic
08083	1-5/8 jic
08082	1-7/8 jic
08085	2-1/2 jic

Availability of Crimp Nuts subject to stock levels being surplus to our requirements.

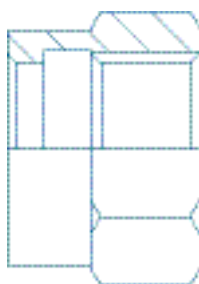

NPSM crimp nut

Code	Description
18004	1/8 npsm
18000	1/4 npsm
18001	3/8 npsm
18002	1/2 npsm
18003	3/4 npsm
18005	1 npsm
18007	1-1/4 npsm
18008	1-1/2 npsm
18009	2 npsm

Availability of Crimp Nuts subject to stock levels being surplus to our requirements.



Contents Section 8

Swepts & Hose-Tails

100	BSP male x BSP male 90° swept elbow
100	BSP male x hose-tail 90° swept
100	BSP male x BSP swivel female 90° swept elbow
100	BSP swivel female x BSP swivel female 90° swept elbow
101	BSP swivel female x PUSH-IN 90° swept elbow
101	BSP swivel female x hose-tail 90° swept elbow
101	BSP swivel female x hose-tail 135° swept
101	JIC male x JIC swivel female 90° swept elbow
102	JIC male x BSP swivel female 90° swept elbow
102	JIC swivel female x PUSH-IN 90° swept elbow
102	BSP male x BSP male 135° swept elbow
102	BSP male x BSP swivel female 135° swept elbow
103	BSP swivel female x BSP swivel female 135° swept elbow
103	BSP swivel female x PUSH-IN 135° swept elbow
103	JIC male x BSP swivel female 135° swept elbow
103	JIC male x JIC swivel female 135° swept elbow
104	JIC swivel female x PUSH-IN 135° swept elbow

Straight Push-Ins & Hose-Tails

104	BSP male x PUSH-IN STRAIGHT
104	BSP male x hose-tail STRAIGHT
104	BSPT male x PUSH-IN STRAIGHT
105	NPTF male x PUSH-IN STRAIGHT
105	NPSM female x hose-tail STRAIGHT
105	JIC male x PUSH-IN STRAIGHT
105	BSP swivel female x PUSH-IN STRAIGHT
106	BSP swivel female x hose-tail STRAIGHT
106	NPTF fixed female x PUSH-IN STRAIGHT
106	JIC swivel female x PUSH-IN STRAIGHT
107	BSP swivel female x hose-tail 90° compact
107	JIC swivel female x hose-tail 90° compact

Ferrules

107	R2A ferrules
107	R2T ferrules

BSP male x BSP male 90° swept elbow

Code	Description
06000	1/4 bsp
06001	3/8 bsp
06002	1/2 bsp
06003	5/8 bsp
06004	3/4 bsp
06005	1 bsp
06006	1-1/4 bsp
06007	1-1/2 bsp
06008	2 bsp

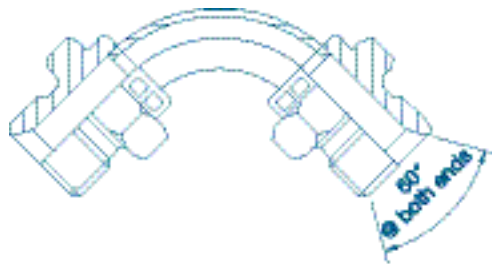

BSP male x hose-tail 90° swept elbow

Code	Description
19930	1/4 bsp x 1/4 hose-tail
19931	3/8 bsp x 3/8 hose-tail
19932	1/2 bsp x 1/2 hose-tail
19933	5/8 bsp x 5/8 hose-tail
19934	3/4 bsp x 3/4 hose-tail
19935	1 bsp x 1 hose-tail

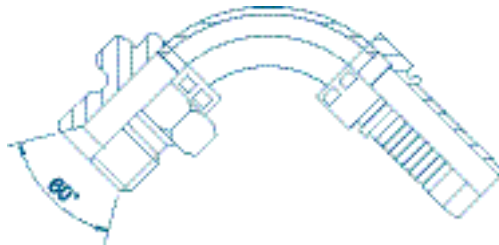

BSP male x BSP swivel female 90° swept elbow

Code	Description
06020	1/4 bsp
06021	3/8 bsp
06022	1/2 bsp
06023	5/8 bsp
06024	3/4 bsp
06025	1 bsp
06026	1-1/4 bsp
06027	1-1/2 bsp
06028	2 bsp

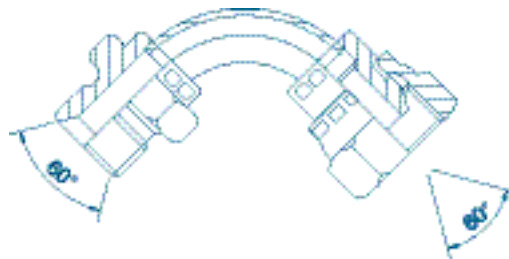

BSP swivel female x BSP swivel female 90° swept elbow

Code	Description
06050	1/4 bsp
06051	3/8 bsp
06052	1/2 bsp
06053	5/8 bsp
06054	3/4 bsp
06055	1 bsp
06056	1-1/4 bsp
06057	1-1/2 bsp
06058	2 bsp

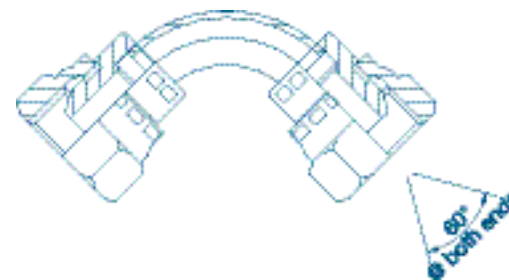

BSP swivel female x PUSH-IN 90° swept elbow

Code	Description
09280	1/4 bsp x 1/4 pi
09281	3/8 bsp x 3/8 pi
09282	1/2 bsp x 1/2 pi
09283	5/8 bsp x 5/8 pi
09284	3/4 bsp x 3/4 pi
09285	1 bsp x 1 pi

All PUSH-INS not for use with Clips or Ferrules.

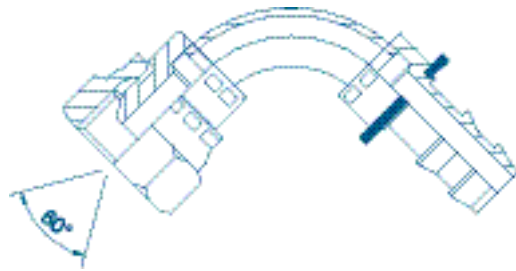

BSP swivel female x hose-tail 90° swept elbow

Code	Description
93000	1/4 bsp x 1/4 hose-tail
93001	3/8 bsp x 3/8 hose-tail
93002	1/2 bsp x 1/2 hose-tail
93003	5/8 bsp x 5/8 hose-tail
93004	3/4 bsp x 3/4 hose-tail
93005	1 bsp x 1 hose-tail
93006	1-1/4 bsp x 1-1/4 hose-tail
93008	1-1/2 bsp x 1-1/2 hose-tail

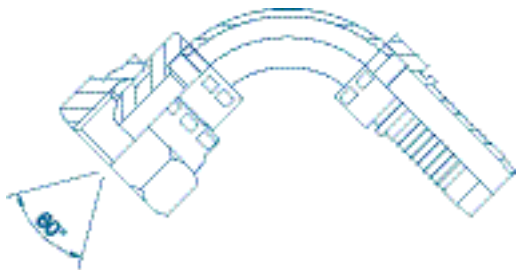

BSP swivel female x hose-tail 135° swept elbow

Code	Description
94500	1/4 bsp x 1/4 hose-tail
94501	3/8 bsp x 3/8 hose-tail
94502	1/2 bsp x 1/2 hose-tail
94504	3/4 bsp x 3/4 hose-tail
94505	1 bsp x 1 hose-tail
94506	1-1/4 bsp x 1-1/4 hose-tail



JIC male x JIC swivel female 90° swept elbow

Code	Description
10900	7/16 jic
10901	1/2 jic
10902	9/16 jic
10903	3/4 jic
10904	7/8 jic
10905	1-1/16 jic
10906	1-3/16 jic
10907	1-5/16 jic
10908	1-5/8 jic
10909	1-7/8 jic

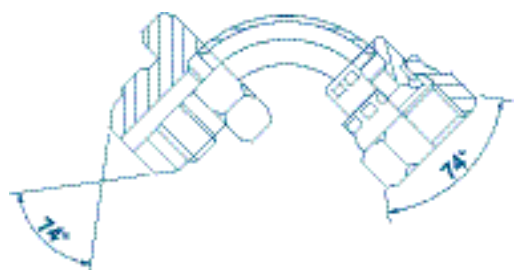

JIC male x BSP swivel female 90° swept elbow

Code	Description
12900	7/16 jic x 1/4 bsp
12901	9/16 jic x 3/8 bsp
12902	3/4 jic x 1/2 bsp
12903	7/8 jic x 5/8 bsp
12904	1-1/16 jic x 3/4 bsp
12905	1-5/16 jic x 1 bsp
12907	1-5/8 jic x 1-1/4 bsp
12906	1-7/8 jic x 1-1/2 bsp



JIC swivel female x PUSH-IN 90° swept

Code	Description
09301	7/16 jic x 1/4 pi
09302	9/16 jic x 3/8 pi
09303	3/4 jic x 1/2 pi
09300	7/8 jic x 5/8 pi
09304	1-1/16 jic x 3/4 pi
09305	1-5/16 jic x 1 pi

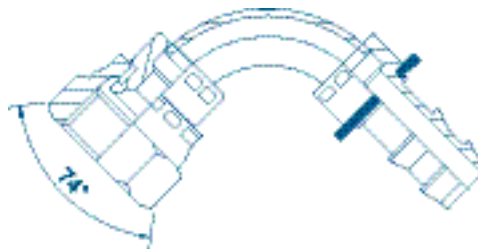

All PUSH-INS not for use with Clips or Ferrules.

BSP male x BSP male 135° swept elbow

Code	Description
16000	1/4 bsp
16001	3/8 bsp
16002	1/2 bsp
16003	5/8 bsp
16004	3/4 bsp
16005	1 bsp
16006	1-1/4 bsp
16007	1-1/2 bsp
16008	2 bsp

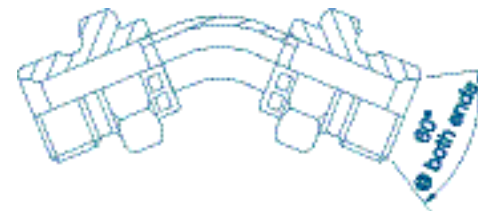

BSP male x BSP swivel female 135° swept elbow

Code	Description
16020	1/4 bsp
16021	3/8 bsp
16022	1/2 bsp
16023	5/8 bsp
16024	3/4 bsp
16025	1 bsp
16026	1-1/4 bsp
16027	1-1/2 bsp
16028	2 bsp



BSP swivel female x BSP swivel female 135° swept elbow

Code	Description
16050	1/4 bsp
16051	3/8 bsp
16052	1/2 bsp
16053	5/8 bsp
16054	3/4 bsp
16055	1 bsp
16056	1-1/4 bsp
16057	1-1/2 bsp
16058	2 bsp



BSP swivel female x PUSH-IN 135° swept elbow

Code	Description
19280	1/4 bsp x 1/4 pi
19281	3/8 bsp x 3/8 pi
19282	1/2 bsp x 1/2 pi
19283	5/8 bsp x 5/8 pi
19284	3/4 bsp x 3/4 pi
19285	1 bsp x 1 pi



All PUSH-INS not for use with Clips or Ferrules.

JIC male x BSP swivel female 135° swept elbow

Code	Description
13900	7/16 jic x 1/4 bsp
13901	9/16 jic x 3/8 bsp
13905	1-1/16 jic x 3/4 bsp
13908	1-5/16 jic x 1 bsp



JIC male x JIC swivel female 135° swept elbow

Code	Description
11900	7/16 jic
11902	9/16 jic
11903	3/4 jic
11905	1-1/16 jic
11907	1-5/16 jic
11908	1-5/8 jic



JIC swivel female x PUSH-IN 135° swept

Code	Description
09320	7/16 jic x 1/4 pi
09321	9/16 jic x 3/8 pi
09322	3/4 jic x 1/2 pi
09323	7/8 jic x 5/8 pi
09324	1-1/16 jic x 3/4 pi

All PUSH-INS not for use with Clips or Ferrules.



BSP male x PUSH-IN STRAIGHT

Code	Description
09220	1/4 bsp x 1/4 pi
09221	3/8 bsp x 3/8 pi
09222	1/2 bsp x 1/2 pi
09225	5/8 bsp x 5/8 pi
09223	3/4 bsp x 3/4 pi
09224	1 bsp x 1 pi

All PUSH-INS not for use with Clips or Ferrules.

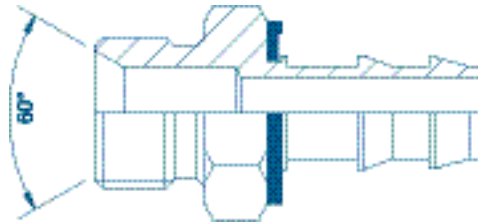

BSP male x hose-tail STRAIGHT

Code	Description
19920	1/4 bsp x 1/4 hose-tail
19921	3/8 bsp x 3/8 hose-tail
19922	1/2 bsp x 1/2 hose-tail
19923	5/8 bsp x 5/8 hose-tail
19924	3/4 bsp x 3/4 hose-tail
19925	1 bsp x 1 hose-tail
19927	1-1/4 bsp x 1-1/4 hose-tail

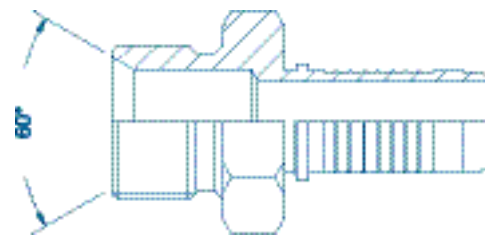

BSPT male x PUSH-IN STRAIGHT

Code	Description
09258	1/8 bspt x 1/4 pi
09250	1/4 bspt x 1/4 pi
09251	3/8 bspt x 3/8 pi
09252	3/8 bspt x 1/2 pi
09256	1/2 bspt x 3/8 pi
09253	1/2 bspt x 1/2 pi
09254	3/4 bspt x 3/4 pi
09255	1 bspt x 1 pi

All PUSH-INS not for use with Clips or Ferrules.

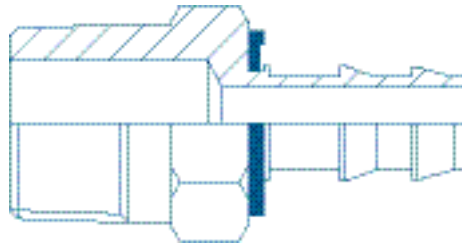

NPTF male x PUSH-IN STRAIGHT

Code	Description
09212	1/8 nptf x 1/4 pi
09213	1/4 nptf x 1/4 pi
09218	1/4 nptf x 3/8 pi
09214	3/8 nptf x 3/8 pi
09219	3/8 nptf x 1/2 pi
09215	1/2 nptf x 1/2 pi
09216	3/4 nptf x 3/4 pi
09217	1 nptf x 1 pi

All PUSH-INS not for use with Clips or Ferrules.

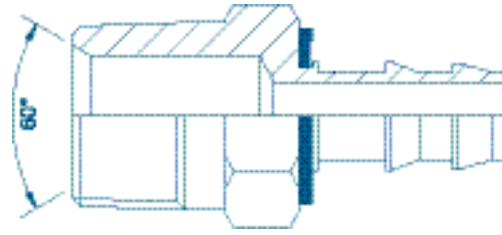

NPSM female x hose-tail STRAIGHT

Code	Description
50000	1/4 npsm x 1/4 hose-tail
50001	3/8 npsm x 3/8 hose-tail

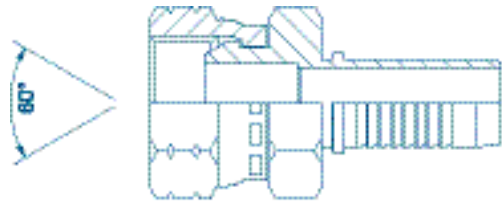

JIC male x PUSH-IN STRAIGHT

Code	Description
09711	7/16 jic x 1/4 pi
09712	9/16 jic x 3/8 pi
09713	3/4 jic x 1/2 pi

All PUSH-INS not for use with Clips or Ferrules.

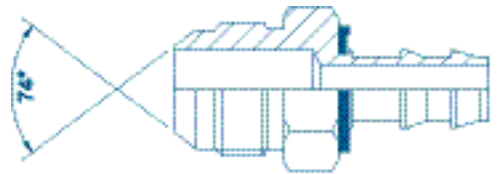

BSP swivel female x PUSH-IN STRAIGHT

Code	Description
09240	1/4 bsp x 1/4 pi
09246	1/4 bsp x 3/8 pi
09241	3/8 bsp x 3/8 pi
09242-06	1/2 bsp x 3/8 pi
09242	1/2 bsp x 1/2 pi
09243	5/8 bsp x 5/8 pi
09244	3/4 bsp x 3/4 pi
09245	1 bsp x 1 pi

All PUSH-INS not for use with Clips or Ferrules.



BSP swivel female x hose-tail STRAIGHT

Code	Description
93099	1/8 bsp x 1/8 hose-tail
93100	1/4 bsp x 1/4 hose-tail
93101	3/8 bsp x 3/8 hose-tail
93102	1/2 bsp x 1/2 hose-tail
93103	5/8 bsp x 5/8 hose-tail
93104	3/4 bsp x 3/4 hose-tail
93105	1 bsp x 1 hose-tail
93106	1-1/4 bsp x 1-1/4 hose-tail
93107	1-1/2 bsp x 1-1/2 hose-tail
93108	2 bsp x 2 hose-tail

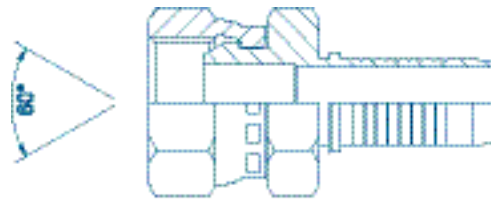

NPTF fixed female x PUSH-IN STRAIGHT

Code	Description
16300	1/4 nptf x 1/4 pi
16301	3/8 nptf x 3/8 pi
16302	1/2 nptf x 1/2 pi

All PUSH-INS not for use with Clips or Ferrules.

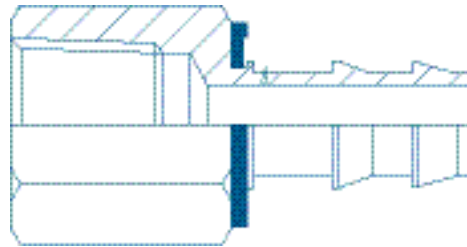

JIC swivel female x PUSH-IN STRAIGHT

Code	Description
09700	7/16 jic x 1/4 pi
09701	9/16 jic x 3/8 pi
09705	3/4 jic x 3/8 pi
09702	3/4 jic x 1/2 pi
09706	7/8 jic x 1/2 pi
09703	7/8 jic x 5/8 pi
09704	1-1/16 jic x 3/4 pi
09707	1-5/16 jic x 1 pi

All PUSH-INS not for use with Clips or Ferrules.

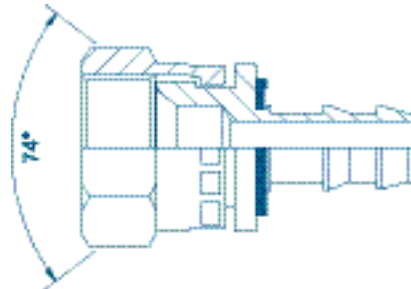

BSP swivel female x hose-tail 90° compact

Code	Description
80001	1/4 bsp x 1/4 hose-tail
80002	3/8 bsp x 3/8 hose-tail
80008	1/2 bsp x 3/8 hose-tail
80003	1/2 bsp x 1/2 hose-tail
80004	5/8 bsp x 5/8 hose-tail
80005	3/4 bsp x 3/4 hose-tail
80006	1 bsp x 1 hose-tail
80007	1-1/4 bsp x 1-1/4 hose-tail

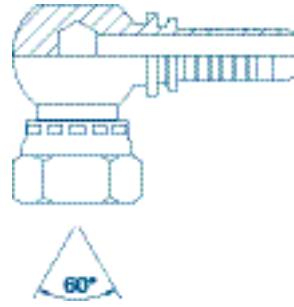

JIC swivel female x hose-tail 90° compact

Code	Description
82000	7/16 jic x 1/4 hose-tail
82001	9/16 jic x 1/4 hose-tail
82002	9/16 jic x 3/8 hose-tail
82003	3/4 jic x 3/8 hose-tail
82004	3/4 jic x 1/2 hose-tail
82005	7/8 jic x 1/2 hose-tail
82006	7/8 jic x 5/8 hose-tail
82007	1-1/16 jic x 5/8 hose-tail
82008	1-1/16 jic x 3/4 hose-tail
82009	1-5/16 jic x 1 hose-tail

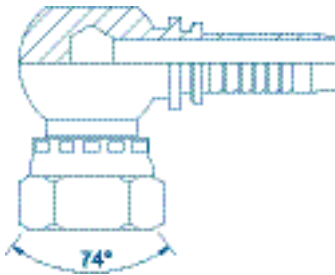

R2A ferrules

Code	Description
19939	1/8 r2a
19940	1/4 r2a
19941	3/8 r2a
19942	1/2 r2a
19943	5/8 r2a
19944	3/4 r2a
19945	1 r2a

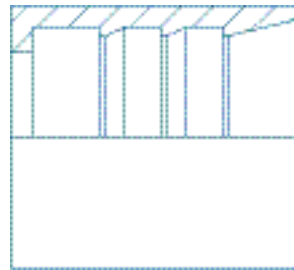

R2T ferrules for non-skived R2T hose

Code	Description
19950	1/4 r2t
19951	3/8 r2t
19956	1/2 r2t
19953	5/8 r2t
19954	3/4 r2t
19955	1 r2t

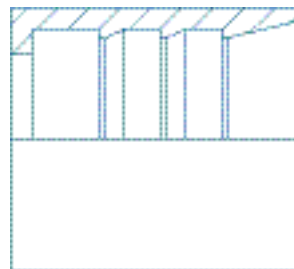

Contents Section 9

109	ORFS male x ORFS male
109	BSP male x ORFS male
110	SAE O'ring boss male LESS O'ring x ORFS male
110	METRIC male 1.5mm pitch 24° cone tube fitting x ORFS male
111	ORFS male x ORFS male BULKHEAD ONLY
111	ORFS bulkhead LOCKNUT
<hr/>	
111	ORFS male x ORFS swivel female
112	BSP male x ORFS swivel female
<hr/>	
112	ORFS male tee
112	ORFS male x ORFS male x ORFS swivel female tee
113	ORFS male x ORFS swivel female x ORFS male tee
<hr/>	
113	ORFS male x ORFS male 90° forged compact elbow
113	ORFS male x ORFS male BULKHEAD 90° ONLY
113	ORFS male x ORFS swivel female 90° forged compact elbow
<hr/>	
114	ORFS male x ORFS swivel female 45° forged compact elbow
<hr/>	
114	ORFS Plug WITH O'RING
114	ORFS caps
<hr/>	
114	ORFS male x BSP male 90° positional forged elbow
115	ORFS male x METRIC male 1.5mm pitch 90° positional forged elbow
115	ORFS male x UNF male 90° positional forged elbow
<hr/>	
116	ORFS male x ORFS male x UNF male positional tee
116	ORFS male x UNF male positional x ORFS male tee
<hr/>	

ORFS male x ORFS male

Code	Description
9305-04-04	9/16 orfs x 9/16 orfs
9305-06-06	11/16 orfs x 11/16 orfs
9305-08-08	13/16 orfs x 13/16 orfs
9305-10-10	1 orfs x 1 orfs
9305-12-12	1-3/16 orfs x 1-3/16 orfs
9305-16-16	1-7/16 orfs x 1-7/16 orfs
9305-20-20	1-11/16 orfs x 1-11/16 orfs
9305-24-24	2 orfs x 2 orfs

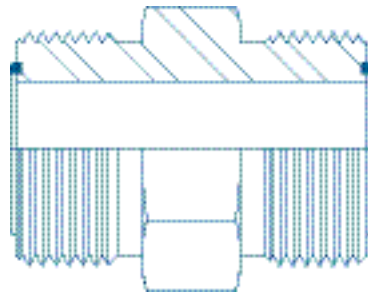

BSP male x ORFS male

Code	Description
74005	1/8 bsp x 9/16 orfs
74024	1/8 bsp x 11/16 orfs
74000	1/4 bsp x 9/16 orfs
74006	1/4 bsp x 11/16 orfs
74019	3/8 bsp x 9/16 orfs
74001	3/8 bsp x 11/16 orfs
74007	3/8 bsp x 13/16 orfs
74015	1/2 bsp x 11/16 orfs
74002	1/2 bsp x 13/16 orfs
74008	1/2 bsp x 1 orfs
74011	1/2 bsp x 1-3/16 orfs
74018	5/8 bsp x 1 orfs
74014	5/8 bsp x 1-3/16 orfs
74009	3/4 bsp x 1 orfs
74003	3/4 bsp x 1-3/16 orfs
74016	3/4 bsp x 1-7/16 orfs
74004	1 bsp x 1-7/16 orfs
74012	1 bsp x 1-11/16 orfs
74022	1-1/4 bsp x 1-3/16 orfs
74010	1-1/4 bsp x 1-11/16 orfs
74013	1-1/2 bsp x 1-11/16 orfs

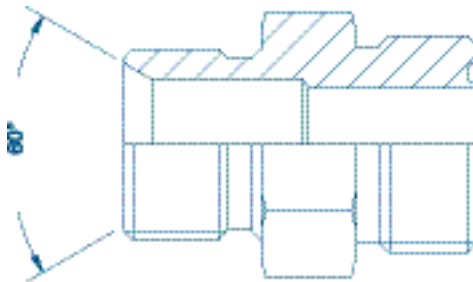

Other O'Ring Face Seal requirements available on quotation.

SAE O'ring boss male LESS O'ring x ORFS male

Code	Description
21300	7/16 sorb x 9/16 orfs
21301	7/16 sorb x 11/16 orfs
21319	9/16 sorb x 9/16 orfs
21302	9/16 sorb x 11/16 orfs
21303	9/16 sorb x 13/16 orfs
21304	3/4 sorb x 11/16 orfs
21305	3/4 sorb x 13/16 orfs
21306	3/4 sorb x 1 orfs
21318	7/8 sorb x 11/16 orfs
21307	7/8 sorb x 13/16 orfs
21308	7/8 sorb x 1 orfs
21317	7/8 sorb x 1-3/16 orfs
21320	1-1/16 sorb x 13/16 orfs
21309	1-1/16 sorb x 1 orfs
21310	1-1/16 sorb x 1-3/16 orfs
21311	1-1/16 sorb x 1-7/16 orfs
21312	1-5/16 sorb x 1-3/16 orfs
21313	1-5/16 sorb x 1-7/16 orfs
21314	1-5/8 sorb x 1-7/16 orfs
21315	1-5/8 sorb x 1-11/16 orfs
21321	1-7/8 sorb x 1-11/16 orfs
21316	1-7/8 sorb x 2 orfs

Other O'Ring Face Seal requirements available on quotation.

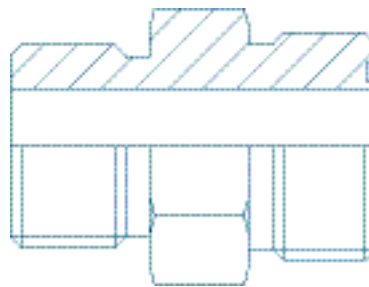

METRIC male 1.5mm pitch 24° cone tube fitting x ORFS male

Code	Description
474007-10	16 mm x 13/16 orfs
474007-8	16 mm x 13/16 orfs

example: **474007** (fitting), **-8** (metric tube size).

Other O'Ring Face Seal requirements available on quotation.

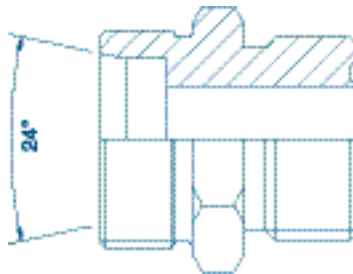

ORFS male x ORFS male BULKHEAD ONLY

Code	Description
9325-04	9/16 orfs
9325-06	11/16 orfs
9325-08	13/16 orfs
9325-10	1 orfs
9325-12	1-3/16 orfs
9325-16	1-7/16 orfs
9325-20	1-11/16 orfs

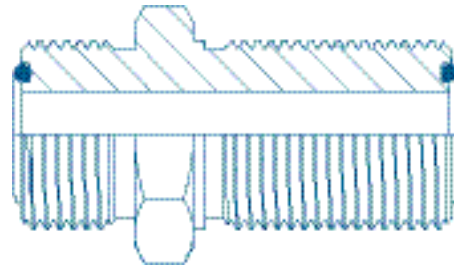

ORFS male bulkhead LOCKNUT

Code	Description
9925-04	9/16 orfs
9925-06	11/16 orfs
9925-08	13/16 orfs
9925-10	1 orfs
9925-12	1-3/16 orfs
9925-16	1-7/16 orfs
9925-20	1-11/16 orfs
9925-24	2 orfs



ORFS male x ORFS swivel female

Code	Description
9015-04-06AS	9/16 orfs x 11/16 orfs
9015-04-12AS	9/16 orfs x 1-3/16 orfs
9015-06-08AS	11/16 orfs x 13/16 orfs
9015-06-12AS	11/16 orfs x 1-3/16 orfs
9015-08-10AS	13/16 orfs x 1 orfs
9015-10-12AS	1 orfs x 1-3/16 orfs
9015-12-16AS	1-3/16 orfs x 1-7/16 orfs
9015-16-20AS	1-7/16 orfs x 1-11/16 orfs

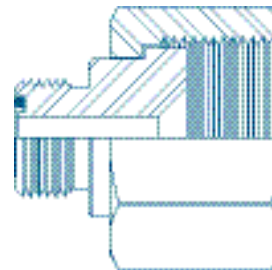

BSP male x ORFS swivel female

Code	Description
96400	1/4 bsp x 9/16 orfs
96410	1/4 bsp x 11/16 orfs
96420	3/8 bsp x 9/16 orfs
96430	3/8 bsp x 11/16 orfs
96440	3/8 bsp x 13/16 orfs
96450	1/2 bsp x 13/16 orfs
96460	1/2 bsp x 1 orfs
96470	3/4 bsp x 1-3/16 orfs
96480	3/4 bsp x 1-7/16 orfs
96490	1 bsp x 1-7/16 orfs
96510	1 bsp x 1-11/16 orfs
96500	1-1/4 bsp x 1-11/16 orfs

Other O'Ring Face Seal requirements available on quotation.

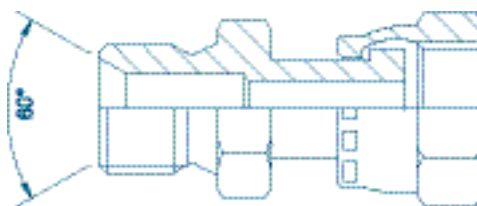

ORFS male tee

Code	Description
9705-04-04-04	9/16 orfs
9705-06-06-06	11/16 orfs
9705-08-08-08	13/16 orfs
9705-10-10-10	1 orfs
9705-12-12-12	1-3/16 orfs
9705-16-16-16	1-7/16 orfs

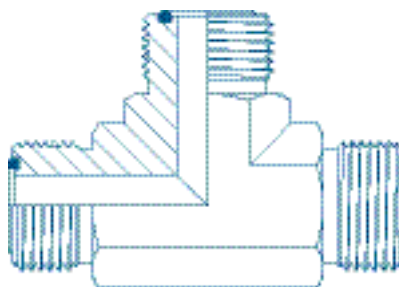

ORFS male x ORFS male x ORFS swivel female tee

Code	Description
9707-04-04-04	9/16 orfs
9707-06-06-06	11/16 orfs
9707-08-08-08	13/16 orfs
9707-10-10-10	1 orfs
9707-12-12-12	1-3/16 orfs
9707-16-16-16	1-7/16 orfs
9707-20-20-20	1-11/16 orfs
9707-24-24-24	2 orfs

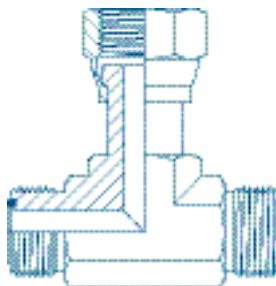

ORFS male x ORFS swivel female x ORFS male tee

Code	Description
9706-04-04-04	9/16 orfs
9706-06-06-06	11/16 orfs
9706-08-08-08	13/16 orfs
9706-10-10-10	1 orfs
9706-12-12-12	1-3/16 orfs
9706-16-16-16	1-7/16 orfs
9706-20-20-20	1-11/16 orfs
9706-24-24-24	2 orfs

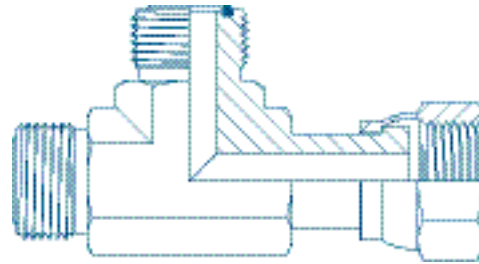

ORFS male x ORFS male 90° forged compact elbow

Code	Description
9505-04-04	9/16 orfs
9505-06-06	11/16 orfs
9505-08-08	13/16 orfs
9505-10-10	1 orfs
9505-12-12	1-3/16 orfs
9505-16-16	1-7/16 orfs
9505-20-20	1-11/16 orfs
9505-24-24	2 orfs

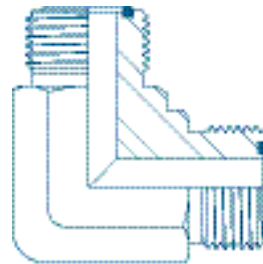

ORFS male x ORFS male BULKHEAD 90° ONLY

Code	Description
9525-04-04	9/16 orfs
9525-06-06	11/16 orfs
9525-08-08	13/16 orfs
9525-10-10	1 orfs
9525-12-12	1-3/16 orfs
9525-16-16	1-7/16 orfs
9525-20-20	1-11/16 orfs
9525-24-24	2 orfs

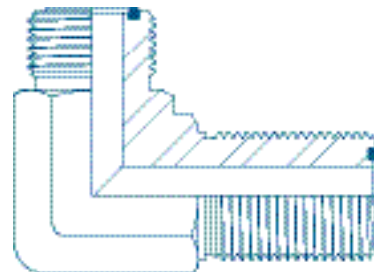

ORFS male x ORFS swivel female 90° forged compact elbow

Code	Description
9506-04-04	9/16 orfs
9506-06-06	11/16 orfs
9506-08-08	13/16 orfs
9506-10-10	1 orfs
9506-12-12	1-3/16 orfs
9506-16-16	1-7/16 orfs
9506-20-20	1-11/16 orfs
9506-24-24	2 orfs

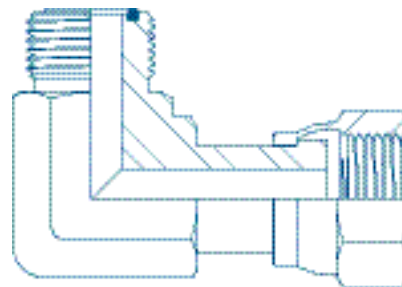

ORFS male x ORFS swivel female 45° forged compact elbow

Code	Description
9356-04-04	9/16 orfs
9356-06-06	11/16 orfs
9356-08-08	13/16 orfs
9356-10-10	1 orfs
9356-12-12	1-3/16 orfs
9356-16-16	1-7/16 orfs
9356-20-20	1-11/16 orfs
9356-24-24	2 orfs

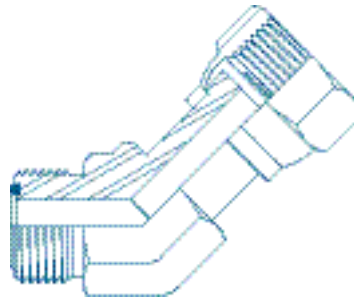

SAE O'ring face plugs WITH O'RING

Code	Description
96000	9/16 orfs
96001	11/16 orfs
96002	13/16 orfs
96003	1 orfs
96004	1-3/16 orfs
96005	1-7/16 orfs
96006	1-11/16 orfs

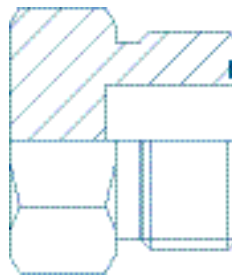

Other O'Ring Face Seal requirements available on quotation.

ORFS caps

Code	Description
9129-04	9/16 orfs
9129-06	11/16 orfs
9129-08	13/16 orfs
9129-10	1 orfs
9129-12	1-3/16 orfs
9129-16	1-7/16 orfs
9129-20	1-11/16 orfs
9129-24	2 orfs

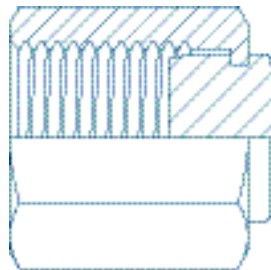

ORFS male x BSP male 90° positional forged elbow

Code	Description
9515-04-04B	9/16 orfs x 1/4 bsp
9515-06-06B	11/16 orfs x 3/8 bsp
9515-08-06B	13/16 orfs x 3/8 bsp
9515-08-08B	13/16 orfs x 1/2 bsp
9515-10-08B	1 orfs x 1/2 bsp
9515-10-10B	1 orfs x 5/8 bsp
9515-12-08B	1-3/16 orfs x 1/2 bsp
9515-12-12B	1-3/16 orfs x 3/4 bsp
9515-16-16B	1-7/16 orfs x 1 bsp

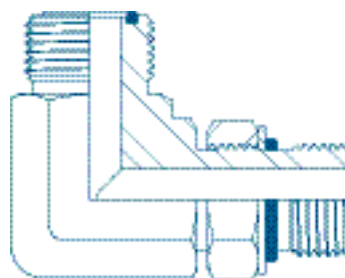

ORFS male x METRIC male 1.5mm pitch 90° positional forged elbow

Code	Description
9515-04-M10	9/16 orfs x 10 mm x 1 mm
9515-04-M12	9/16 orfs x 12 mm
9515-04-M14	9/16 orfs x 14 mm
9515-04-M16	9/16 orfs x 16 mm
9515-04-M18	9/16 orfs x 18 mm
9515-06-M16	11/16 orfs x 16 mm
9515-06-M18	11/16 orfs x 18 mm
9515-06-M20	11/16 orfs x 20 mm
9515-06-M22	11/16 orfs x 22 mm
9515-08-M12	13/16 orfs x 12 mm
9515-08-M14	13/16 orfs x 14 mm
9515-08-M16	13/16 orfs x 16 mm
9515-08-M18	13/16 orfs x 18 mm
9515-08-M20	13/16 orfs x 20 mm
9515-08-M22	13/16 orfs x 22 mm
9515-10-M16	1 orfs x 16 mm
9515-10-M18	1 orfs x 18 mm
9515-10-M20	1 orfs x 20 mm
9515-10-M22	1 orfs x 22 mm

Code	Description
9515-12-M16	1-3/16 orfs x 16 mm
9515-12-M18	1-3/16 orfs x 18 mm
9515-12-M20	1-3/16 orfs x 20 mm
9515-12-M22	1-3/16 orfs x 22 mm
9515-12-M24	1-3/16 orfs x 24 mm
9515-12-M26	1-3/16 orfs x 26 mm

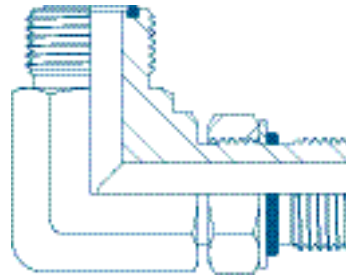

ORFS male x UNF male 90° positional forged elbow

Code	Description
9515-04-04	9/16 orfs x 7/16 unf
9515-04-06	9/16 orfs x 9/16 unf
9515-06-06	11/16 orfs x 9/16 unf
9515-06-08	11/16 orfs x 3/4 unf
9515-08-08	13/16 orfs x 3/4 unf
9515-10-10	1 orfs x 7/8 unf
9515-10-12	1 orfs x 1-1/16 unf
9515-12-08	1-3/16 orfs x 3/4 unf
9515-12-12	1-3/16 orfs x 1-1/16 unf
9515-12-16	1-3/16 orfs x 1-5/16 unf
9515-16-16	1-7/16 orfs x 1-5/16 unf
9515-20-20	1-11/16 orfs x 1-5/8 unf

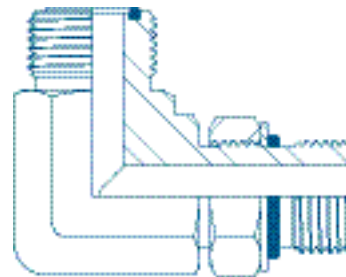

Also available in 45° - please enquire.

ORFS male x ORFS male x UNF male positional tee

Code	Description
9715-04-04-04	9/16 orfs x 9/16 orfs x 7/16 unf
9715-06-06-06	11/16 orfs x 11/16 orfs x 9/16 unf
9715-08-08-08	13/16 orfs x 13/16 orfs x 3/4 unf
9715-10-10-10	1 orfs x 1 orfs x 7/8 unf
9715-12-12-12	1-3/16 orfs x 1-3/16 orfs x 1-1/16 unf
9715-16-16-16	1-7/16 orfs x 1-7/16 orfs x 1-5/16 unf
9715-20-20-20	1-11/16 orfs x 1-11/16 orfs x 1-5/8 unf
9715-24-24-24	2 orfs x 2 orfs x 1-7/8 unf

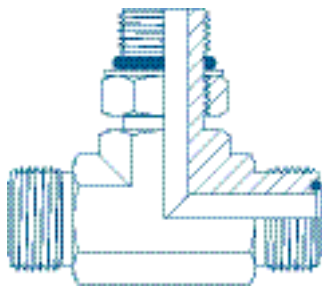

ORFS male x UNF male positional x ORFS male tee

Code	Description
9716-04-04-04	9/16 orfs x 7/16 unf x 9/16 orfs
9716-06-06-06	11/16 orfs x 9/16 unf x 11/16 orfs
9716-08-08-08	13/16 orfs x 3/4 unf x 13/16 orfs
9716-10-10-10	1 orfs x 7/8 unf x 1 orfs
9716-12-12-12	1-3/16 orfs x 1-1/16 unf x 1-3/16 orfs
9716-16-16-16	1-7/16 orfs x 1-5/16 unf x 1-7/16 orfs
9716-20-20-20	1-11/16 orfs x 1-5/8 unf x 1-11/16 orfs
9716-24-24-24	2 orfs x 1-7/8 unf x 2 orfs

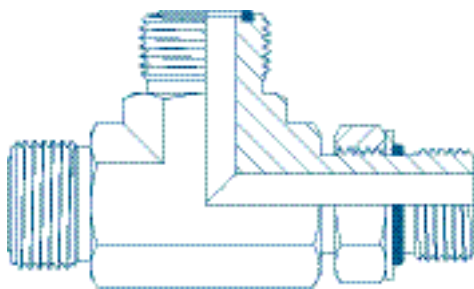

Contents Section 10

118 BSP male x BSP male 90° positional forged elbow

118 BSP male x BSP male 45° positional forged elbow

118 JIC male x BSP male 90° positional forged elbow

119 JIC male x UNF male 90° positional forged elbow

119 JIC male x UNF male 45° positional forged elbow

119 JIC male x METRIC male 1.5mm pitch 90° positional forged elbow

120 JIC male x JIC male 90° forged compact elbow

120 JIC male x JIC male bulkhead 90° forged compact elbow

120 JIC male x JIC male bulkhead 45° forged compact elbow

121 JIC male x JIC swivel female 90° forged compact elbow

121 JIC male x JIC swivel female 45° forged compact elbow

121 NPTF male x JIC male 90° forged compact elbow

122 NPTF male x JIC male 45° forged compact elbow

122 BSP swivel female x BSP swivel female 90° forged compact elbow

122 BSP male x BSP swivel female 90° forged compact elbow

122 BSP male x BSP swivel female 45° forged compact elbow

123 JIC male tee forged

123 JIC male x JIC male x UNF male positional tee

123 JIC male x UNF male positional x JIC male tee

124 JIC male x JIC male x JIC swivel female forged branch tee

124 JIC male x JIC swivel female x JIC male forged branch tee

BSP male x BSP male 90° positional forged elbow

Code	Description
03051FDPOS	1/4 bsp
03053FDPOS	3/8 bsp
03054FDPOS	1/2 bsp
03056FDPOS	3/4 bsp
03057FDPOS	1 bsp
03058FDPOS	1-1/4 bsp

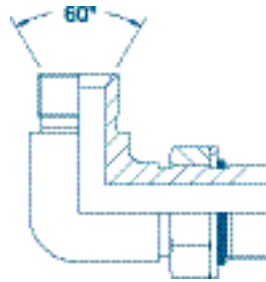

BSP male x BSP male 45° positional forged elbow

Code	Description
03051FDPOS-45	1/4 bsp
03053FDPOS-45	3/8 bsp
03054FDPOS-45	1/2 bsp
03056FDPOS-45	3/4 bsp
03057FDPOS-45	1 bsp
03058FDPOS-45	1-1/4 bsp

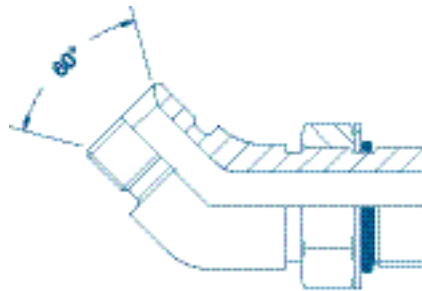

JIC male x BSP male 90° positional forged elbow

Code	Description
27070FDPOS	7/16 jic x 1/4 bsp
27072FDPOS	9/16 jic x 1/4 bsp
27073FDPOS	9/16 jic x 3/8 bsp
27077FDPOS	3/4 jic x 3/8 bsp
27074FDPOS	3/4 jic x 1/2 bsp
27080FDPOS	7/8 jic x 3/8 bsp
27079FDPOS	7/8 jic x 1/2 bsp
27075FDPOS	1-1/16 jic x 3/4 bsp
27076FDPOS	1-5/16 jic x 1 bsp
27067FDPOS	1-7/8 jic x 1-1/2 bsp

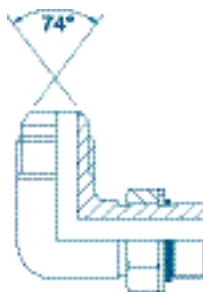

JIC male x UNF male 90° positional forged elbow

Code	Description
03085FDPOS	7/16 jic x 7/16 unf
03085-06FDPOS	7/16 jic x 9/16 unf
03086FDPOS	1/2 jic x 1/2 unf
03087-04FDPOS	9/16 jic x 7/16 unf
03087FDPOS	9/16 jic x 9/16 unf
03095FDPOS	3/4 jic x 9/16 unf
03088FDPOS	3/4 jic x 3/4 unf
03089-06FDPOS	7/8 jic x 9/16 unf
03096FDPOS	7/8 jic x 3/4 unf
03089FDPOS	7/8 jic x 7/8 unf
03090FDPOS	1-1/16 jic x 1-1/16 unf
03090-16FDPOS	1-1/16 jic x 1-5/16 unf
03092FDPOS	1-5/16 jic x 1-5/16 unf
03094FDPOS	1-5/8 jic x 1-5/8 unf

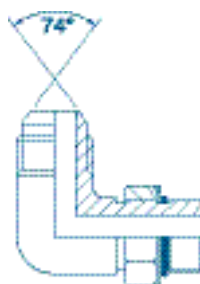

JIC male x UNF male 45° positional forged elbow

Code	Description
03085FDPOS-45	7/16 jic x 7/16 unf
03086FDPOS-45	1/2 jic x 1/2 unf
03087FDPOS-45	9/16 jic x 9/16 unf
03088FDPOS-45	3/4 jic x 3/4 unf
03089FDPOS-45	7/8 jic x 7/8 unf
03090FDPOS-45	1-1/16 jic x 1-1/16 unf
03092FDPOS-45	1-5/16 jic x 1-5/16 unf

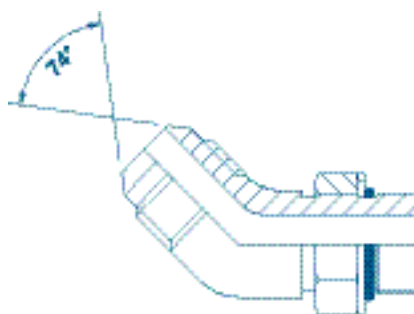

JIC male x METRIC male 1.5mm pitch 90° positional forged elbow

Code	Description
29499FDPOS	7/16 jic x 10 mm x 1 mm
29500FDPOS	7/16 jic x 12 mm
29501FDPOS	7/16 jic x 14 mm
29502FDPOS	9/16 jic x 16 mm
29503FDPOS	9/16 jic x 18 mm
29504FDPOS	3/4 jic x 16 mm
29505FDPOS	3/4 jic x 18 mm
29506FDPOS	3/4 jic x 20 mm
29507FDPOS	3/4 jic x 22 mm
29508FDPOS	7/8 jic x 22 mm
29509FDPOS	1-1/16 jic x 22 mm



JIC male x JIC male 90° forged compact elbow

Code	Description
03085FD	7/16 jic x 7/16 jic
03086FD	1/2 jic x 1/2 jic
03087FD	9/16 jic x 9/16 jic
03088FD	3/4 jic x 3/4 jic
03089FD	7/8 jic x 7/8 jic
03090FD	1-1/16 jic x 1-1/16 jic
03091FD	1-3/16 jic x 1-3/16 jic
03092FD	1-5/16 jic x 1-5/16 jic
03094FD	1-5/8 jic x 1-5/8 jic
03093FD	1-7/8 jic x 1-7/8 jic

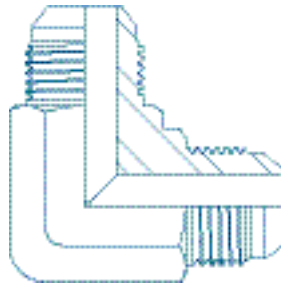

JIC male x JIC male BULKHEAD 90° forged compact elbow

Code	Description
10525-03	3/8 jic x 3/8 jic
10525-04	7/16 jic x 7/16 jic
10525-05	1/2 jic x 1/2 jic
10525-06	9/16 jic x 9/16 jic
10525-08	3/4 jic x 3/4 jic
10525-10	7/8 jic x 7/8 jic
10525-12	1-1/16 jic x 1-1/16 jic
10525-16	1-5/16 jic x 1-5/16 jic
10525-20	1-5/8 jic x 1-5/8 jic

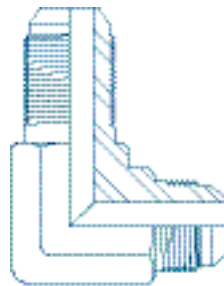

JIC male x JIC male BULKHEAD 45° forged compact elbow

Code	Description
10375-04	7/16 jic x 7/16 jic
10375-05	1/2 jic x 1/2 jic
10375-06	9/16 jic x 9/16 jic
10375-08	3/4 jic x 3/4 jic
10375-10	7/8 jic x 7/8 jic
10375-12	1-1/16 jic x 1-1/16 jic
10375-16	1-5/16 jic x 1-5/16 jic
10375-20	1-5/8 jic x 1-5/8 jic

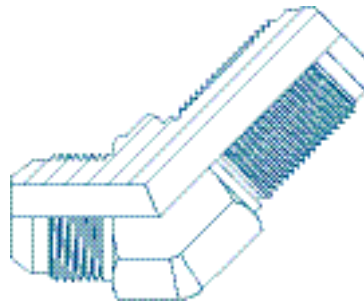

Please see Section 1 for Locknuts.

JIC male x JIC swivel female 90° forged compact elbow

Code	Description
05050FD	7/16 jic x 7/16 jic
05051FD	1/2 jic x 1/2 jic
05052FD	9/16 jic x 9/16 jic
05053FD	3/4 jic x 3/4 jic
05054FD	7/8 jic x 7/8 jic
05055FD	1-1/16 jic x 1-1/16 jic
05057FD	1-3/16 jic x 1-3/16 jic
05056FD	1-5/16 jic x 1-5/16 jic
05058FD	1-5/8 jic x 1-5/8 jic
05059FD	1-7/8 jic x 1-7/8 jic



JIC male x JIC swivel female 45° forged compact elbow

Code	Description
05050/45FD	7/16 jic x 7/16 jic
05051/45FD	1/2 jic x 1/2 jic
05052/45FD	9/16 jic x 9/16 jic
05053/45FD	3/4 jic x 3/4 jic
05054/45FD	7/8 jic x 7/8 jic
05055/45FD	1-1/16 jic x 1-1/16 jic
05056/45FD	1-5/16 jic x 1-5/16 jic
05058/45FD	1-5/8 jic x 1-5/8 jic
05059/45FD	1-7/8 jic x 1-7/8 jic

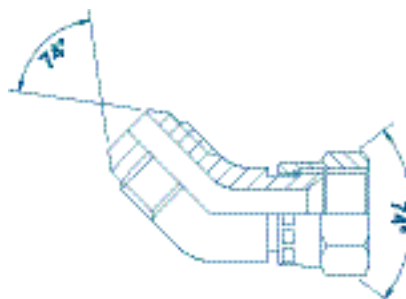

NPTF male x JIC male 90° forged compact elbow

Code	Description
04050FD	1/8 nptf x 7/16 jic
04053FD	1/4 nptf x 7/16 jic
04057FD	3/8 nptf x 7/16 jic
04059FD	3/8 nptf x 9/16 jic
04060FD	3/8 nptf x 3/4 jic
04064FD	1/2 nptf x 9/16 jic
04065FD	1/2 nptf x 3/4 jic
04066FD	1/2 nptf x 7/8 jic
04071FD	3/4 nptf x 3/4 jic
04072FD	3/4 nptf x 7/8 jic
04073FD	3/4 nptf x 1-1/16 jic
04076FD	1 nptf x 1-5/16 jic
04079FD	1-1/4 nptf x 1-5/8 jic
04080FD	1-1/2 nptf x 1-7/8 jic
04081FD	2 nptf x 2-1/2 jic

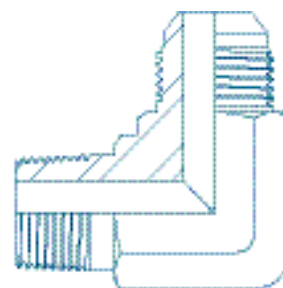

NPTF male x JIC male 45° forged compact elbow

Code	Description
04050/45FD	1/8 nptf x 7/16 jic
04053/45FD	1/4 nptf x 7/16 jic
04055/45FD	1/4 nptf x 9/16 jic
04059/45FD	3/8 nptf x 9/16 jic
04060/45FD	3/8 nptf x 3/4 jic
04065/45FD	1/2 nptf x 3/4 jic
04066/45FD	1/2 nptf x 7/8 jic
04073/45FD	3/4 nptf x 1-1/16 jic
04075/45FD	3/4 nptf x 1-5/16 jic
04076/45FD	1 nptf x 1-5/16 jic

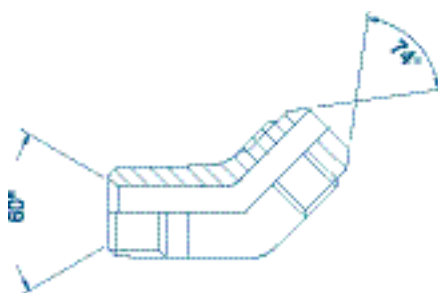

BSP swivel female x BSP swivel female 90° forged compact elbow

Code	Description
05026FD	1/4 bsp x 1/4 bsp
05027FD	3/8 bsp x 3/8 bsp
05028FD	1/2 bsp x 1/2 bsp
05030FD	3/4 bsp x 3/4 bsp
05031FD	1 bsp x 1 bsp



BSP male x BSP swivel female 90° forged compact elbow

Code	Description
05000FD	1/4 bsp x 1/4 bsp
05001FD	3/8 bsp x 3/8 bsp
05002FD	1/2 bsp x 1/2 bsp
05004FD	3/4 bsp x 3/4 bsp
05005FD	1 bsp x 1 bsp
05018FD	1-1/4 bsp x 1-1/4 bsp
05007FD	1-1/2 bsp x 1-1/2 bsp

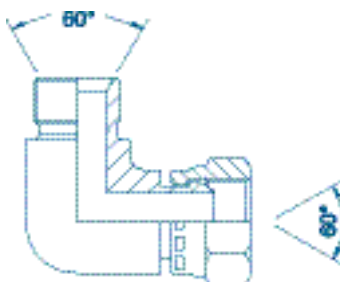

BSP male x BSP swivel female 45° forged compact elbow

Code	Description
05000/45FD	1/4 bsp x 1/4 bsp
05001/45FD	3/8 bsp x 3/8 bsp
05002/45FD	1/2 bsp x 1/2 bsp
05004/45FD	3/4 bsp x 3/4 bsp
05005/45FD	1 bsp x 1 bsp

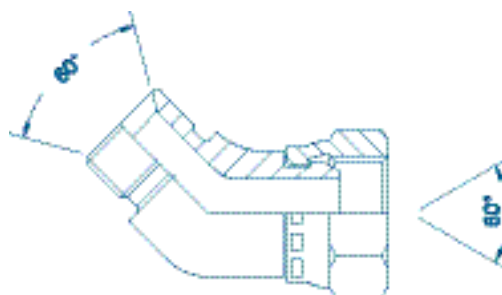

JIC male forged tee

Code	Description
01949FD	3/8 jic
01950FD	7/16 jic
01952FD	9/16 jic
01953FD	3/4 jic
01954FD	7/8 jic
01955FD	1-1/16 jic

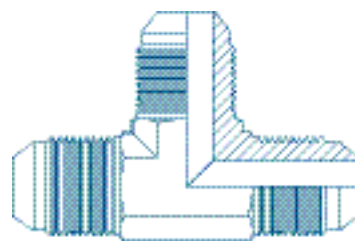

JIC male x JIC male x UNF male positional tee

Code	Description
10715-04-04-04	7/16 jic x 7/16 jic x 7/16 unf
10715-05-05-05	1/2 jic x 1/2 jic x 1/2 unf
10715-06-06-06	9/16 jic x 9/16 jic x 9/16 unf
10715-08-08-08	3/4 jic x 3/4 jic x 3/4 unf
10715-10-10-10	7/8 jic x 7/8 jic x 7/8 unf
10715-12-12-12	1-1/16 jic x 1-1/16 jic x 1-1/16 unf
10715-14-14-14	1-3/16 jic x 1-3/16 jic x 1-3/16 unf
10715-16-16-16	1-5/16 jic x 1-5/16 jic x 1-5/16 unf
10715-20-20-20	1-5/8 jic x 1-5/8 jic x 1-5/8 unf
10715-24-24-24	1-7/8 jic x 1-7/8 jic x 1-7/8 unf

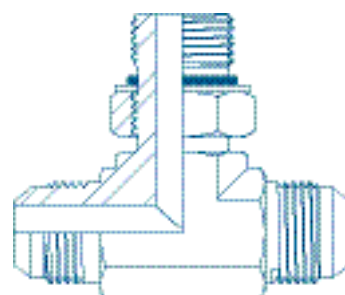

JIC male x UNF positional male x JIC male tee

Code	Description
10716-04-04-04	7/16 jic x 7/16 unf x 7/16 jic
10716-05-05-05	1/2 jic x 1/2 unf x 1/2 jic
10716-06-06-06	9/16 jic x 9/16 unf x 9/16 jic
10716-08-08-08	3/4 jic x 3/4 unf x 3/4 jic
10716-10-10-10	7/8 jic x 7/8 unf x 7/8 jic
10716-12-12-12	1-1/16 jic x 1-1/16 unf x 1-1/16 jic
10716-14-14-14	1-3/16 jic x 1-3/16 unf x 1-3/16 jic
10716-16-16-16	1-5/16 jic x 1-5/16 unf x 1-5/16 jic
10716-20-20-20	1-5/8 jic x 1-5/8 unf x 1-5/8 jic
10716-24-24-24	1-7/8 jic x 1-7/8 unf x 1-7/8 jic

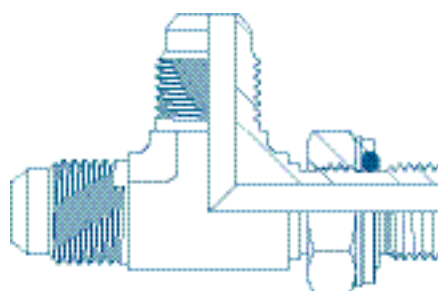

JIC male x JIC male x JIC swivel female branch forged tee

Code	Description
02053FD	7/16 jic
02050FD	9/16 jic
02051FD	3/4 jic
02054FD	1-1/16 jic

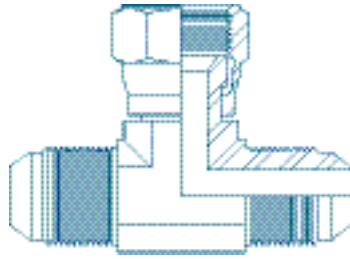

JIC male x JIC swivel female x JIC male branch forged tee

Code	Description
12040FD	7/16 jic
12042FD	9/16 jic
12043FD	3/4 jic
12044FD	7/8 jic
12045FD	1-1/16 jic
12046FD	1-5/16 jic
12047FD	1-5/8 jic

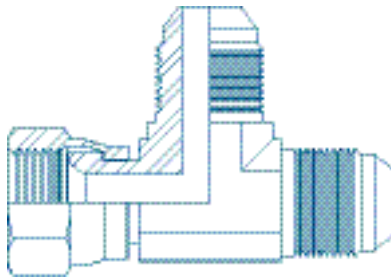

Contents Section 11

126 60° double cones for BSP ends

126 60° double cones for METRIC ends

126 JIS male x JIS male (BSP threads)

126 BSP male x JIS male (BSP threads)

127 BSPT male x JIS male (BSP threads)

127 JIC male x JIS male (BSP threads)

127 JIS solid plug (BSP threads)

127 JIS fixed female cap (BSP threads)

128 JIC male x JIS fixed female extended 60° internal seat (BSP threads)

128 JIS male x JIS male (METRIC threads)

128 JIC male x JIS male (METRIC threads)

128 JIS solid plug (METRIC threads)

129 JIS fixed female cap (METRIC threads)

129 JIC male x JIS fixed female extended 60° internal seat (METRIC threads)

129 JIS male x JIS swivel female 90° swept elbow (BSP threads)

60° double cones for BSP ends

Code	Description
DC-04	1/4 bsp
DC-06	3/8 bsp
DC-08	1/2 bsp
DC-12	3/4 bsp
DC-16	1 bsp
DC-20	1-1/4 bsp

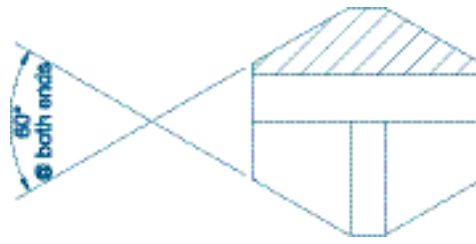

60° double cones for METRIC ends

Code	Description
DMC-12	12 mm
DMC-14	14 mm
DMC-16	16 mm
DMC-18	18 mm
DMC-20	20 mm
DMC-22	22 mm
DMC-24	24 mm
DMC-26	26 mm

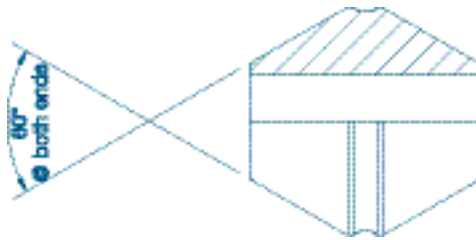

JIS male x JIS male (BSP threads)

Code	Description
7801-04-04	1/4 jis
7801-06-06	3/8 jis
7801-08-08	1/2 jis
7801-12-12	3/4 jis

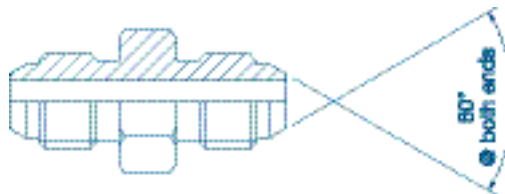

BSP male x JIS male (BSP threads)

Code	Description
00005JIS	1/4 bsp x 1/4 jis
00014JIS	3/8 bsp x 3/8 jis

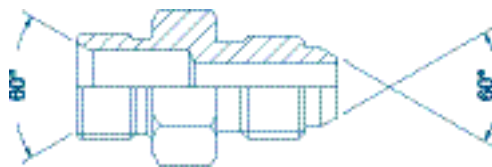

BSPT male x JIS male (BSP threads)

Code	Description
00306-JIS	1/4 bspt x 1/4 jis
00313-JIS	3/8 bspt x 3/8 jis
00321-JIS	1/2 bspt x 1/2 jis
00334-JIS	3/4 bspt x 3/4 jis
00340-JIS	1 bspt x 1 jis

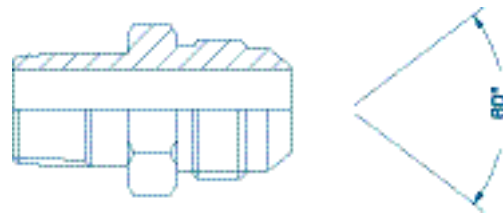

JIC male x JIS male (BSP threads)

Code	Description
6811-04-02	7/16 jic x 1/8 jis
6811-04-04	7/16 jic x 1/4 jis
6811-06-06	9/16 jic x 3/8 jis
6811-08-08	3/4 jic x 1/2 jis

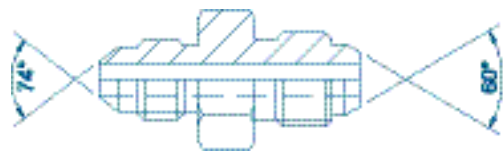

JIS solid plug (BSP threads)

Code	Description
7681-02	1/8 jis
7681-04	1/4 jis
7681-06	3/8 jis
7681-08	1/2 jis
7681-12	3/4 jis

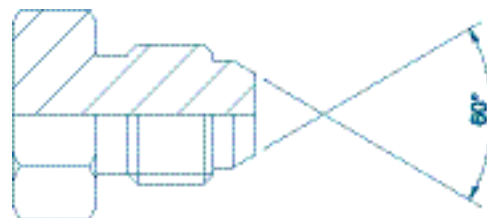

JIS fixed female cap (BSP threads)

Code	Description
7691-04	1/4 jis
7691-06	3/8 jis
7691-08	1/2 jis
7691-12	3/4 jis

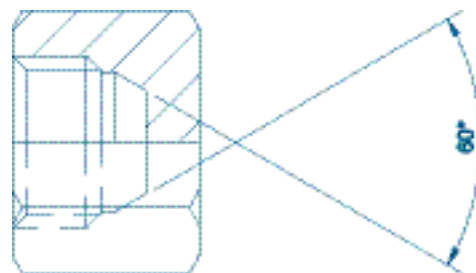

JIC male x JIS fixed female extended 60° internal seat (BSP threads)

Code	Description
6677-04-04	7/16 jic x 1/4 jis
6677-06-06	9/16 jic x 3/8 jis
6677-08-08	3/4 jic x 1/2 jis
6677-12-12	1-1/16 jic x 3/4 jis

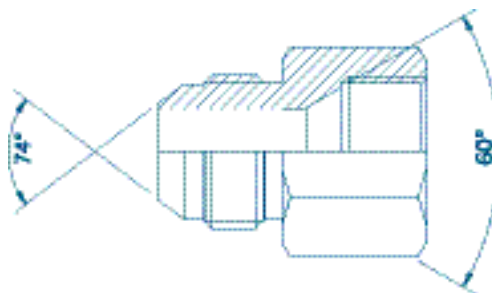

JIS male x JIS male (METRIC threads)

Code	Description
9741-14	14 jis x 14 jis
9741-18	18 jis x 18 jis
9741-22	22 jis x 22 jis
9741-24	24 jis x 24 jis
9741-30	30 jis x 30 jis
9741-33	33 jis x 33 jis

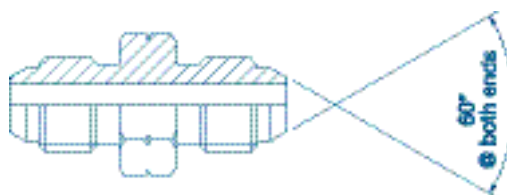

JIC male x JIS male (METRIC threads)

Code	Description
8751-04-14	7/16 jic x 14 jis
8751-06-18	9/16 jic x 18 jis
8751-08-22	3/4 jic x 22 jis
8751-10-24	7/8 jic x 24 jis
8751-12-30	1-1/16 jic x 30 jis
8751-16-33	1-5/16 jic x 33 jis



JIS solid plug (METRIC threads)

Code	Description
9711-14	14 jis
9711-18	18 jis
9711-22	22 jis
9711-24	24 jis
9711-30	30 jis
9711-33	33 jis

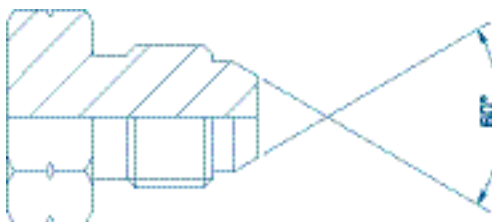

JIS fixed female cap (METRIC threads)

Code	Description
9721-14	14 jis
9721-18	18 jis
9721-22	22 jis
9721-24	24 jis
9721-30	30 jis
9721-33	33 jis

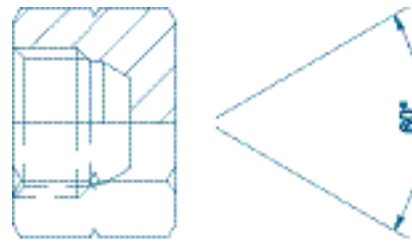

JIC male x JIS fixed female extended 60° internal seat (METRIC threads)

Code	Description
8701-04-14	7/16 jic x 14 jis
8701-06-18	9/16 jic x 18 jis
8701-08-22	3/4 jic x 22 jis
8701-10-24	7/8 jic x 24 jis
8701-12-30	1-1/16 jic x 30 jis
8701-16-33	1-5/16 jic x 33 jis

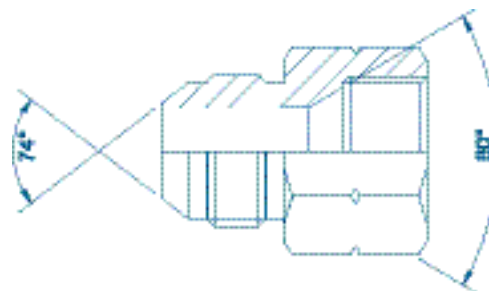

JIS male x JIS swivel female 90° swept elbow (BSP threads)

Code	Description
06020JIS	1/4 jis
06021JIS	3/8 jis
06022JIS	1/2 jis
06024JIS	3/4 jis
06025JIS	1 jis

135° available on request.

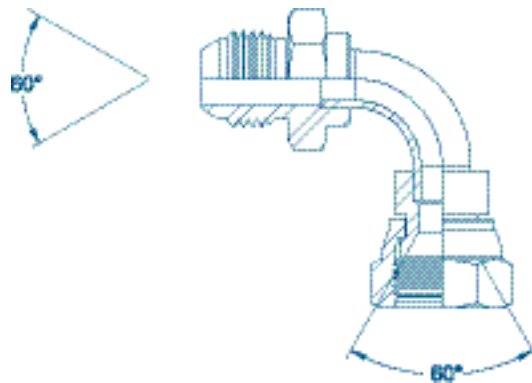

Contents Section 12

131 O'Rings for SAE boss male

131 O'Rings for ORFS

131 BSP self centering bonded seal

132 METRIC self centering bonded seal

132 BSP plastic protection caps

O'RINGS for SAE boss male

Code	Description
01413	5/16
01412	3/8
01400	7/16
01408	1/2
01401	9/16
01409	5/8
01402	3/4
01403	7/8
01404	1-1/16
01410	1-3/16
01405	1-5/16
01406	1-5/8
01407	1-7/8
01411	2-1/2



O'RINGS for ORFS

Code	Description
81400	9/16
81401	11/16
81402	13/16
81403	1
81404	1-3/16
81405	1-7/16
81406	1-11/16
81407	2



BSP self centering bonded seal

Code	Description
BBS-2	1/8 bsp
BBS-4	1/4 bsp
BBS-6	3/8 bsp
BBS-8	1/2 bsp
BBS-10	5/8 bsp
BBS-12	3/4 bsp
BBS-16	1 bsp
BBS-20	1-1/4 bsp
BBS-24	1-1/2 bsp
BBS-28	1-3/4 bsp
BBS-32	2 bsp
BBS-40	2-1/2 bsp



METRIC self centering bonded seal

Code	Description
MBS-08	8 mm
MBS-10	10 mm
MBS-12	12 mm
MBS-14	14 mm
MBS-16	16 mm
MBS-18	18 mm
MBS-20	20 mm
MBS-22	22 mm
MBS-24	24 mm
MBS-26	26 mm
MBS-30	30 mm
MBS-36	36 mm



BSP plastic protection cap

Code	Description
BRC-2	1/8 bsp
BRC-4	1/4 bsp
BRC-6	3/8 bsp
BRC-8	1/2 bsp
BRC-10	5/8 bsp
BRC-12	3/4 bsp
BRC-16	1 bsp
BRC-20	1-1/4 bsp
BRC-24	1-1/2 bsp
BRC-32	2 bsp



IMPORTANT Failure to comply could result in delays with orders etc.

Orders

- Please order by our CATALOGUE CODE NUMBER ONLY.
- We accept orders via phone, email, on-line or preferably by FAX.
- You can order as much or as little as you like. We do however, reserve the right to apply a £5.00 small order charge on orders under £10.00.
- Please clearly state despatch method.
- We will make every effort to ensure your delivery arrives on time. Sometimes due to circumstances beyond our control, deliveries are delayed. Should this happen we will do our best to get your goods to you as soon as possible and minimise any inconvenience.
- Please clearly cross out and rewrite any errors arising when making out the order.
- Confirmations and additions of orders must be clearly marked. Failure to do so could result in duplication of order which may accrue a handling charge.
- Additions to orders already placed will receive extra carriage and packing charges.
- There will be a charge for orders cancelled when in despatch.
- Order cancellations must be confirmed in writing.
- Out of stock items will be supplied on a supply or cancel basis unless otherwise instructed.
- Orders are processed on a First in First Out (FIFO) basis.
- Goods quoted as being in stock at time of enquiry may not be in stock if an order is placed at a later time.
- You are advised to check goods upon receipt and notify any shortages within 7 days.
- Schedules are processed in the last week of the month. We regret we cannot accept any changes during this period.
- Please DO NOT mix schedule orders with normal orders.
- Requests for specials must be accompanied with a detailed drawing.
- Quotations issued for specials must be signed and returned before adaptors can be manufactured.

Postal Deliveries

- All postal items are subject to a packing charge.
- 1st class postal orders will be recorded delivery only.
- Postings are at customer's own risk.

Carriers

- We offer next day service, timed next day deliveries and Saturday AM by our current carrier.
- You are however at liberty to arrange your own carriage. Please allow a minimum of 2 hours before collecting goods, alternatively ask the Sales Clerk for approx. time for collection. Please place your order before arranging carriers to collect on your behalf.
- We can supply goods direct to your customer. Also if you require goods the same day we can offer a Same Day Service.
- On receipt of goods you are advised to check the number of parcels you are signing for.

Returned Goods

- A handling charge may be made on goods ordered and returned for credit.
- A credit note will only be issued on receipt of goods (subject to acceptance by Quality Control)
- We regret we cannot accept any goods back without prior notification. Returns to be notified within 7 days.
- Returned goods must be accompanied by full documentation ie. Order Numbers, Delivery Note Numbers and reason for return. Goods must be securely packed to avoid damage.

New Accounts

- All new accounts are on a pro-forma basis.
- Providing that all credit checks are approved, then our standard terms of sale apply.

Additional Information on Adaptors

- Unless stated otherwise all adaptors are plated according to our Letter of Conformity.
- BSP adaptors have 60° coned seats unless otherwise stated.
- METRIC male adaptors have 60° coned seats and all threads are 1.5mm pitch unless otherwise stated.
- A letter of conformity is included for you to photocopy.
- Certificates of Conformity available on request.
- Mill Certificates are available on request, however there may be a small charge.
- Plated Stock items required Unplated will incur a charge (P.O.A)

All adaptors manufactured from steel BSEN10277: 3: 1999 230 MO7Pb

B.S.P Adaptor Dimensions		B & H Standards Compatible with ISO 8434-6/BS5200
B.S.P Adaptors DIN SPEC	To	DIN 3852 FORM A: 1991
B.S.P Parallel Threads	To	BSENISO228 - 1: 2003
N.C.B Threads	To	BSENISO228 - 1: 2003
B.S.P.T Threads	To	BSEN 10226 - 1: 2004
JIC & SAE Threads	To	B.S 1580
METRIC Threads	To	B.S 3643 Pt 2: 1981
NPTF Threads	To	ANSI B1 20.1: 1983
Electro Plating	To	FeZn/8/A ISO 4042
JIC Fittings	To	SAE J514 JUN 95 or ISO 8434-2: 1994

The purchaser of these adaptors must ensure that they are satisfactory for use in the application for which they are intended.

No responsibility can be accepted by the manufacturers if adaptors are wrongly applied or incorrectly or inadequately fitted, ie. torque values, pressure requirements, non-matching threads etc.

These goods may not be acceptable to M.O.D requirements.

Adaptor Pressure Ratings Applicable to Bore Size Only

Nominal Bore Dia.		Design Working Pressure		Proof Pressure		Over Pressure	
mm	ins	BAR	psi	BAR	psi	BAR	psi
5	1/8	350	5145	525	7718	1400	20580
6.3	1/4	450	6500	675	9750	1520	22000
10	3/8	380	5500	570	8250	1310	19000
12.5	1/2	310	4500	465	6750	1100	16000
14.25	9/16	289	4250	434	6375	964	14170
16	5/8	280	4000	420	6000	850	12350
19	3/4	240	3500	360	5250	750	11000
25	1	210	3000	315	4500	675	9750
31.5	1-1/4	170	2500	255	3750	530	7700
37.5	1-1/2	136	2000	204	3000	404	5940
50	2	136	2000	204	3000	404	5940
62.5	2-1/2	84	1240	126	1860	245	3596
75	3	76	1120	114	1680	216	3170

Tube Pressure Ratings Applicable to SWEPTS Only - Not Applicable to PUSH-IN SWEPTS

Outer Diameter of Tube		Design Working Pressure		Proof Pressure		Over Pressure	
mm	ins	BAR	psi	BAR	psi	BAR	psi
4.7	3/16	303.4	4400	455	6600	910	13200
6.3	1/4	391	5570	586	8500	1173	17000
10	3/8	303.4	4400	455	6600	910	13200
12.5	1/2	261	3790	392	5685	784	11370
16	5/8	209	3030	313	4545	626	9090
19	3/4	216.75	3140	324	4710	649	9420
25	1	211.65	3070	317	4600	634	9200
31.5	1-1/4	188.7	2735	282	4100	565	8200
37.5	1-1/2	173	2515	260	3770	520	7545
50	2	130	1885	195	2830	390	5655

Design Working Pressure -

Recommended pressure rating for adaptors manufactured by Burnett & Hillman

Nut Tightening Torques - Lightly Oiled Threads

BSP Hydraulic Adaptor Connections

Nominal Size of Nut	Tightening Torque	
BSP Size	Nm	Lbsf/ft
1/8	17	12
1/4	34	25
3/8	47	35
1/2	102	75
5/8	122	90
3/4	149	110
1	203	150
1-1/4	305	225
1-1/2	305	225
2	400	296

O.R.F.S Hydraulic Hose Connections

Nominal Size of Nut			Tightening Torque	
SAE Dash	Thread	Equivalent BSP Size	Nm	Lbsf/ft
-4	9/16-18	1/4	24	18
-6	11/16-16	3/8	33	24
-8	13/16-16	1/2	44	35
-10	1-14	5/8	58	43
-12	1-3/16-12	3/4	84	62
-16	1-7/16-12	1	115	85
-20	1-11/16-12	1-1/4	189	140
-24	2-12	1-1/2	244	180

Metric

Nominal Size of Nut	Tightening Torque	
	Nm	Lbsf/ft
M10	18	13
M12	20	15
M14	25	19
M16	45	33
M18	50	37
M20	70	52
M22	75	55
M26	110	81
M27	130	96
M33	220	162
M42	230	170
M48	350	258

JIC & SAE Connections

Nominal Size of Nut	Tightening Torque	
	Nm	Lbsf/ft
5/16-24	10	7
3/8-24	10	7
7/16-20	14	10
1/2-20	20	15
9/16-18	22	20
5/8-18	27	20
3/4-16	48	35
7/8-14	81	60
1-1/16-12	108	79
1-3/16-12	136	100
1-5/16-12	148	108
1-5/8-12	173	127
1-7/8-12	216	158
2-1/2-12	334	245

Note - Tightening torques relate to counterpart made of steel.

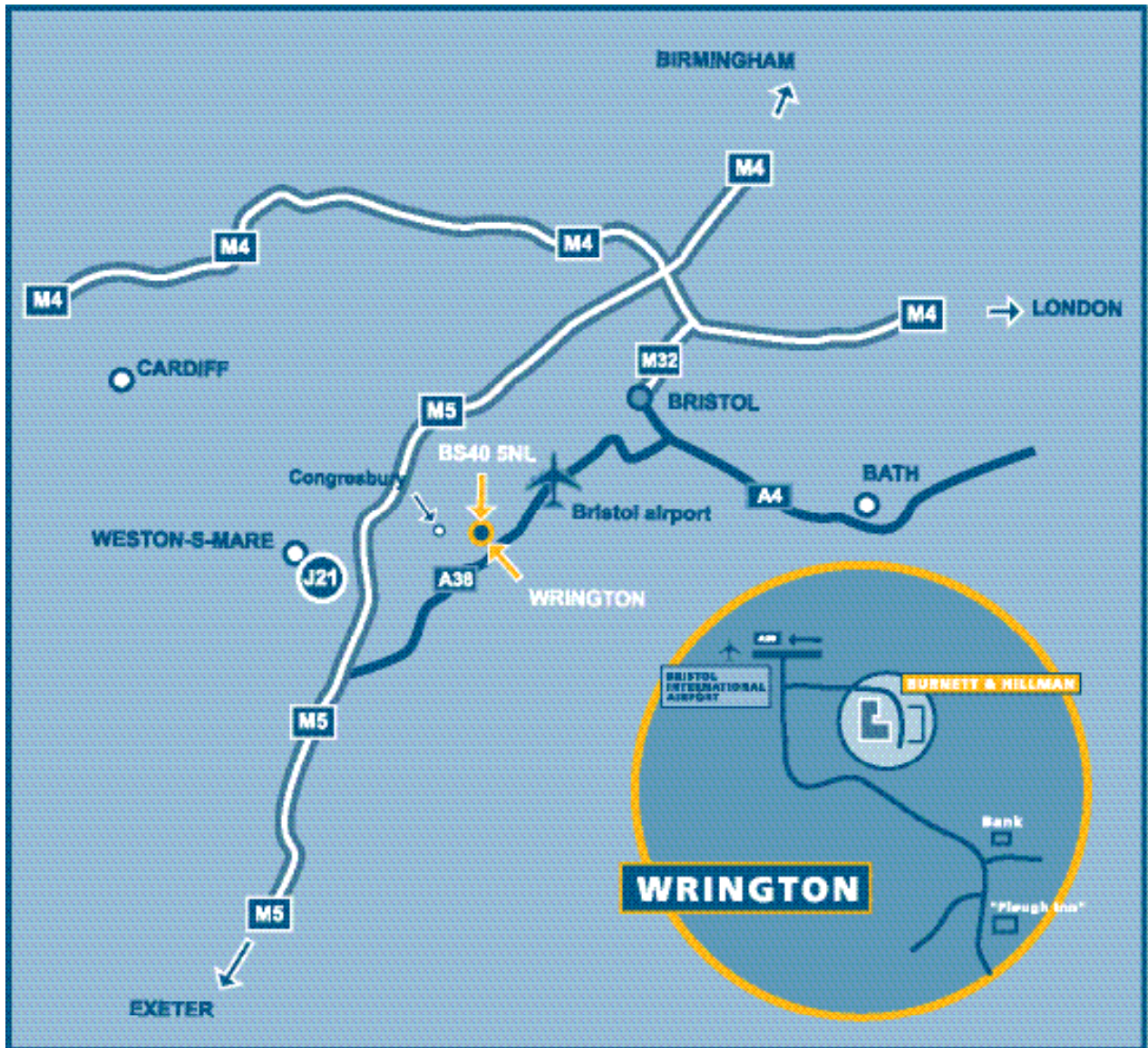

FROM THE M5

1. From Junction 21 on the M5, follow signs for A370 Congresbury. After approximately 5 miles enter the village of Congresbury.
2. Go through 2 sets of traffic lights (staying on the A370 Bristol).
3. After the garage on your right hand side, take the next turning right, signposted Wrington.
4. Travel for approximately 2 miles to Wrington.
5. Take the immediate left after the garage into Silver Street.
6. After 1/2 mile, pass the Burnett Industrial Estate on your right. Burnett & Hillman is signposted on your right hand side and is located behind the PJ Hare factory.

FROM BRISTOL INTERNATIONAL AIRPORT

1. Follow signs Taunton A38, (M5 South). In 1/2 mile at roundabout take 1st exit.
2. After approximately 1 1/2 miles pass the Darlington Arms public house.
3. Take 3rd turning right into Havyat Road. After approximately 1 mile, Burnett & Hillman is signposted on your left hand side.



BURNETT & HILLMAN
HYDRAULIC ADAPTORS

www.burnettandhillman.co.uk

BURNETT & HILLMAN
HYDRAULIC ADAPTORS



Burnett & Hillman, Havyat Road, Wrington, Bristol BS40 5AE, United Kingdom

Tel (Sales): +44 (0)1934 862596 Tel (Accounts): +44 (0)1934 862980

Fax: +44 (0)1934 862616 email: sales@burnettandhillman.co.uk